

Low-mass di-leptons in J-PRAC E16

K. Ozawa (KEK)

Contents

- J-PARC and Hadron Experimental Facility
- Di-electron measurements @ J-PARC
 - Vector meson mass spectra in nucleus
- Further possibility in pA measurements



J-PARC

Tokai, Japan

(Japan Proton Accelerator Research Complex)

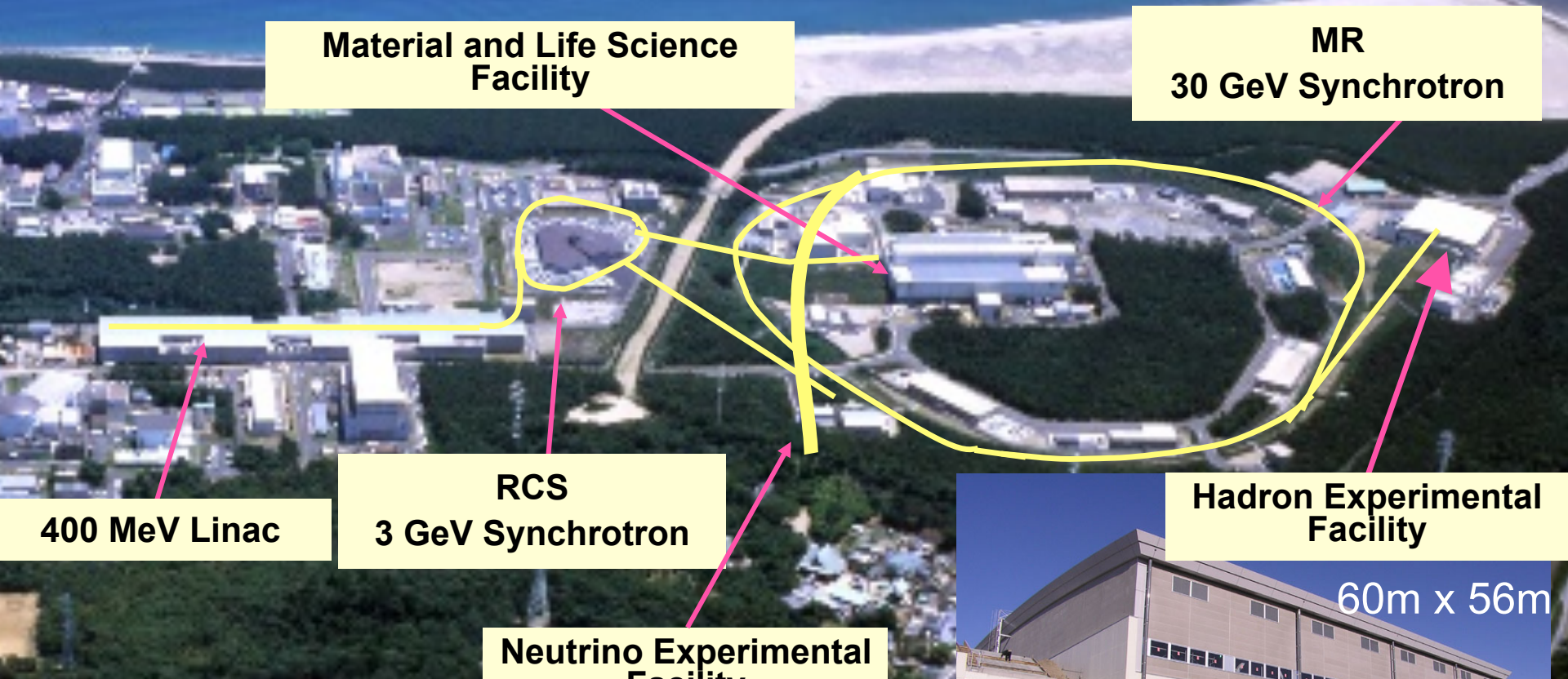

Material and Life Science Facility

**MR
30 GeV Synchrotron**

400 MeV Linac

**RCS
3 GeV Synchrotron**

Neutrino Experimental Facility

Hadron Experimental Facility



60m x 56m

30 GeV Accelerator & Hadron Experimental Facility

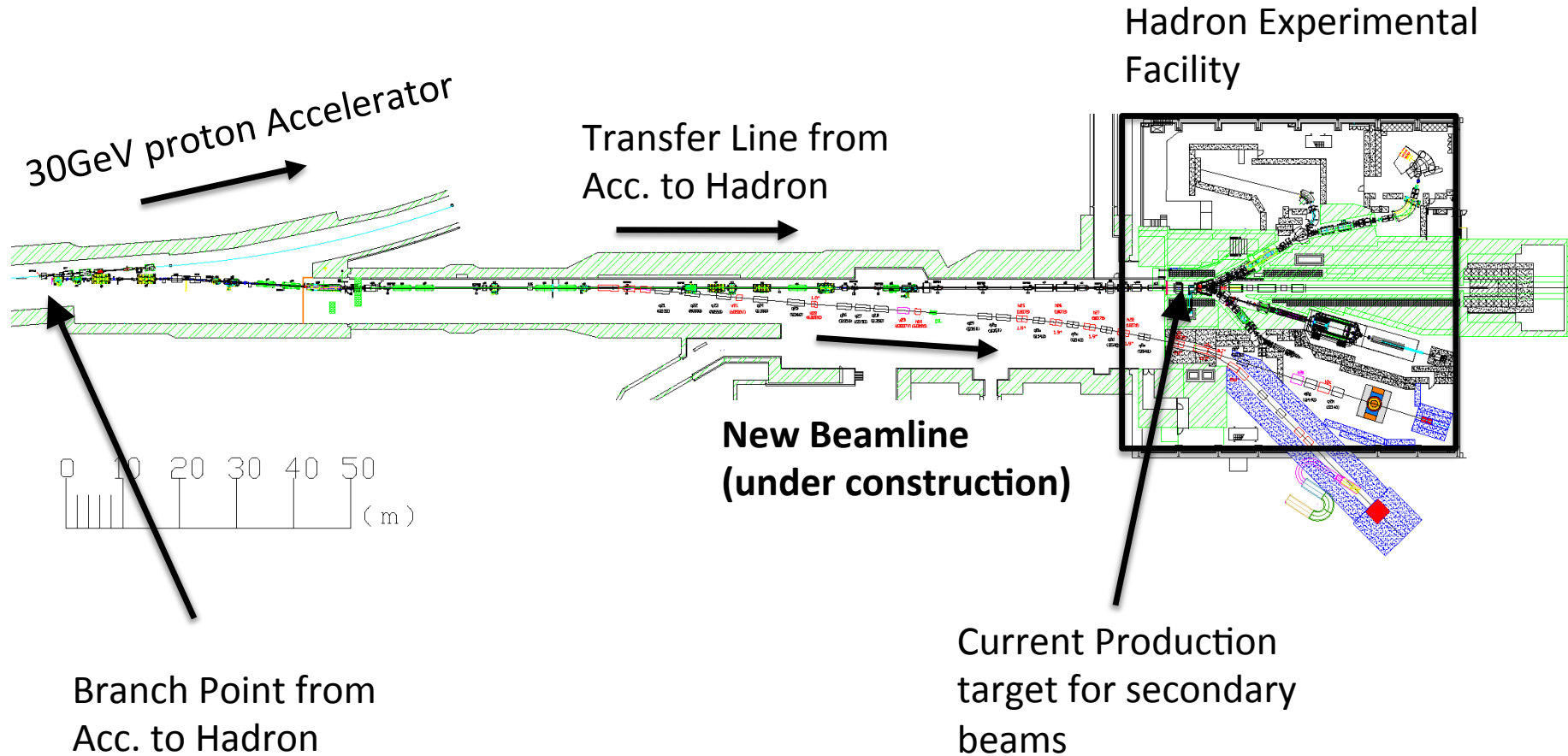

Hadron Experimental Facility

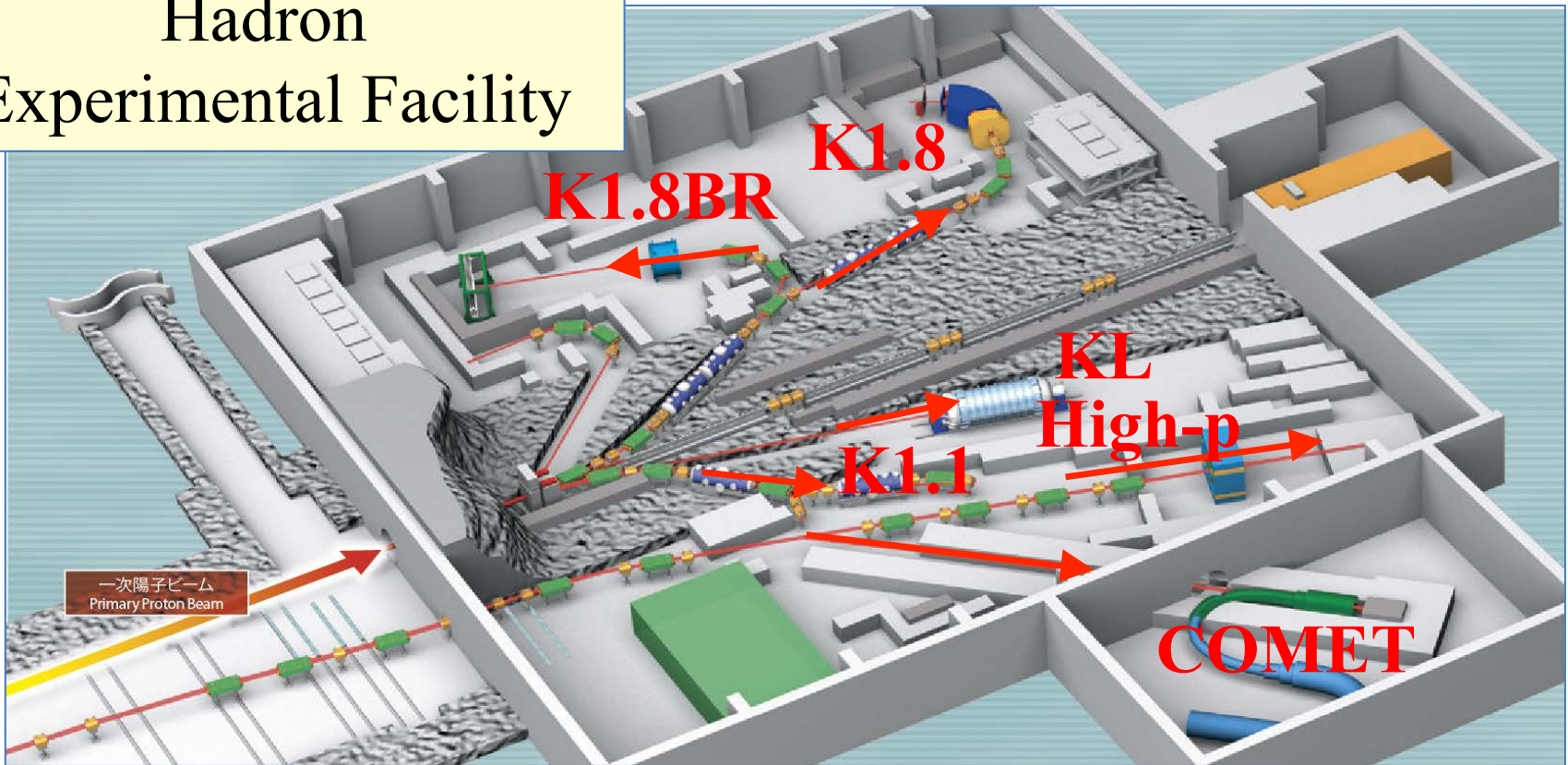

Name	Species	Energy	Intensity	
K1.8	π^\pm, K^\pm	$< 2.0 \text{ GeV}/c$	$\sim 10^5 \text{ Hz}$ for K^+	
K1.8BR	π^\pm, K^\pm	$< 1.0 \text{ GeV}/c$	$\sim 10^4 \text{ Hz}$ for K^+	
K1.1	π^\pm, K^\pm	$< 1.1 \text{ GeV}/c$	$\sim 10^4 \text{ Hz}$ for K^+	
High-p	proton	30GeV	$\sim 10^{10} \text{ Hz}$	Under Construction
	Unseparated	$< 20\text{GeV}/c$	$\sim 10^8 \text{ Hz}$	

QCD medium

QCD: Quantum Chromo Dynamics

K. Fukushima and T. Hatsuda, Rep. Prog. Phys. 74 (2011) 014001

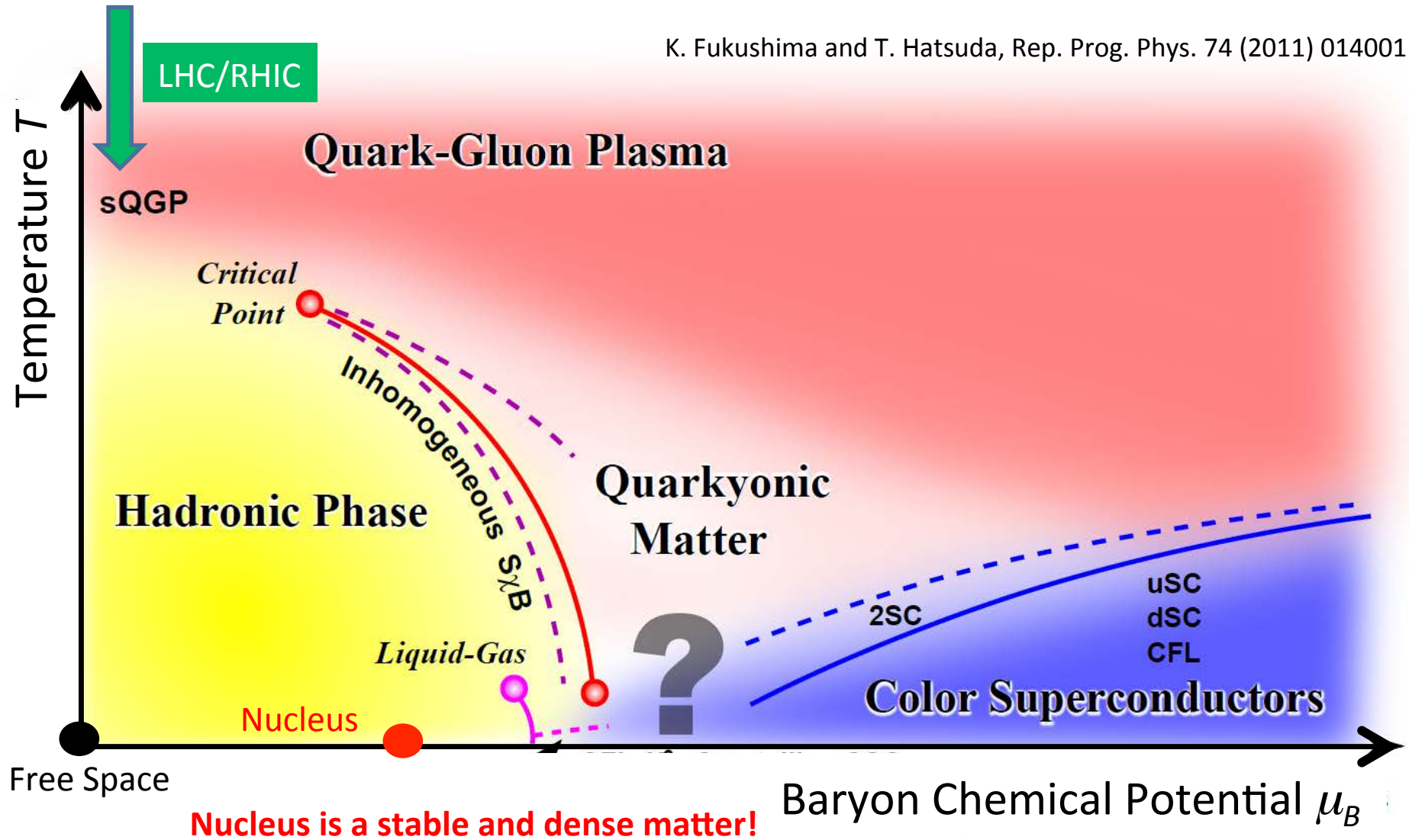

Hadron and QCD medium

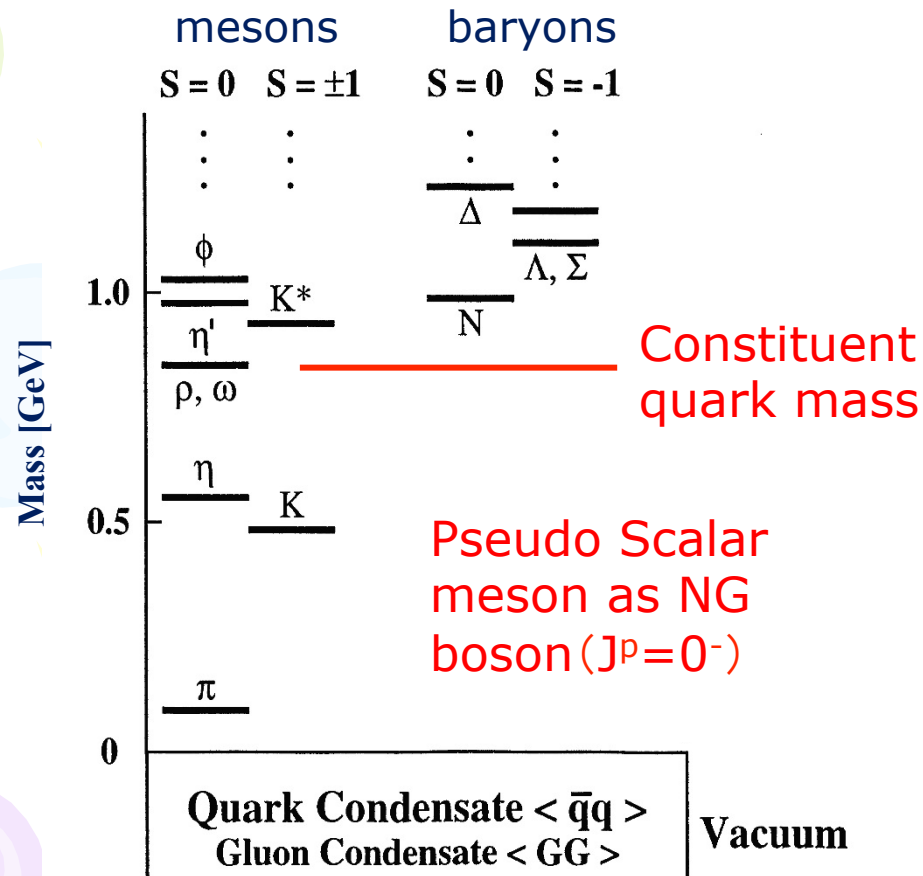

- Hadron mass is understood a sum of constituent quark masses
 - Dynamical mass
- The fact that π meson has a “too light” mass ($M_\pi \sim 130 \text{ MeV}/c^2$) is understood as NG boson of chiral symmetry breaking.
- In fact, chiral symmetry is broken in the real world.
 - masses of chiral partners are different.
 - ρ ($J^P = 1^-$) $m=770 \text{ MeV}$
 a_1 ($J^P = 1^+$) $m=1250 \text{ MeV}$

QCD phase and $\langle \bar{q}q \rangle$

- Spontaneous breaking of a symmetry is marked by:
 - * a non-zero order parameter, the quark condensate $\langle \bar{q}q \rangle$ in the case of QCD

$$\langle \bar{q}q \rangle \approx 250 \text{ MeV}^3$$



$$\langle \bar{q}q \rangle \approx 0 \quad \text{High } T \\ \text{High } \rho$$

heavy ion reactions:

$$A+A \rightarrow V+X$$

$$m_V(\rho \gg \rho_0; T \gg 0)$$

SPS

At Nuclear Density

γ, π, p - beams

J-PARC
LEPS2

elementary reaction:

$$\gamma, p, \pi \rightarrow V+X$$

$$m_V(\rho = \rho_0; T = 0)$$

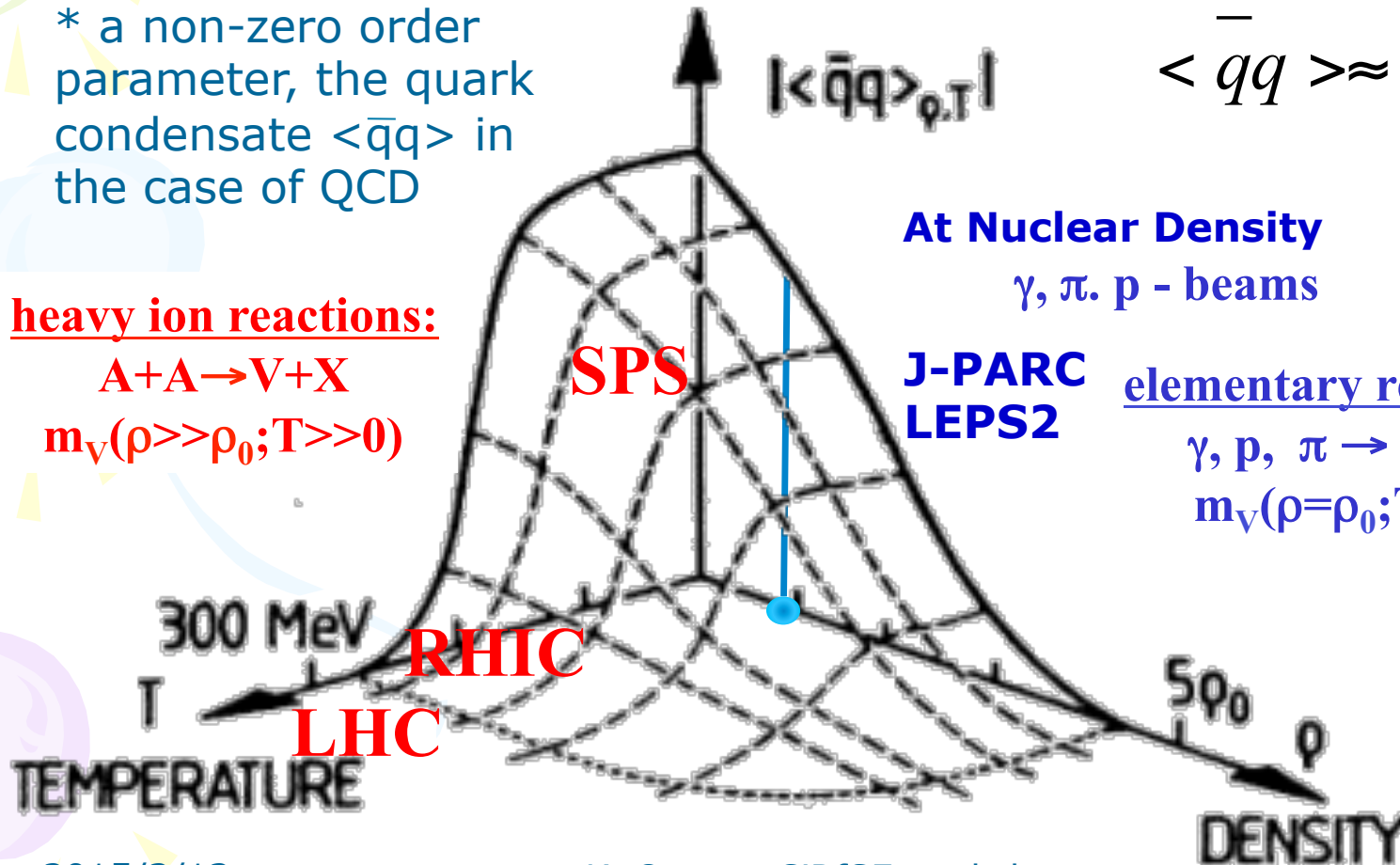

Observables

However, the quark condensate is not an observable and one needs to find observables which are related to the quark condensate.

We need to find out observables related to quark condensates. Relations between mass spectra of V-AV mesons and condensates is developed using a sum rule.

Hatsuda, Koike and Lee, Nucl. Phys. B394 (1993) 221
Kapusta and Shuryak, Phys. Rev. D49 (1994) 4694

$$\int_0^{\infty} d\omega^2 \omega^2 (\rho_V(\omega) - \rho_A(\omega)) = -\frac{4\pi}{3} \alpha_s \langle \mathcal{O}_{4q} \rangle$$

In free space, there is a good measurement done by the ALEPH group. (ALEPH, Phys. Rep. 421(2005) 191) See the next slide.

Condensates and spectra

ALEPH, Phys. Rep. 421(2005) 191

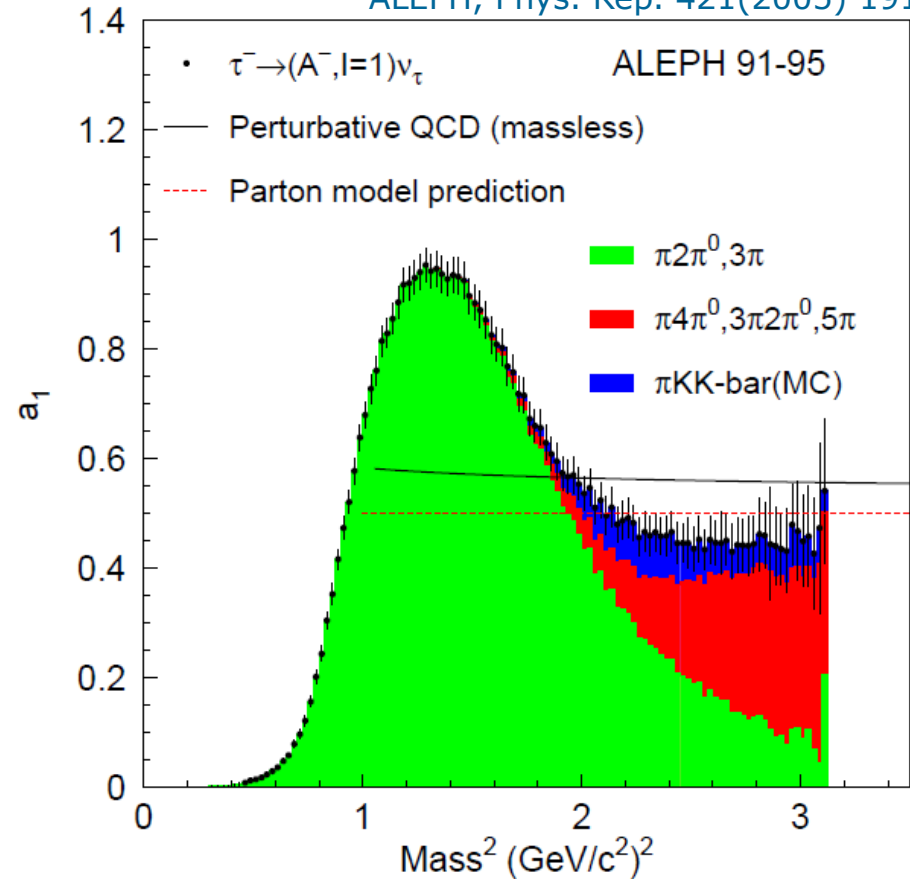
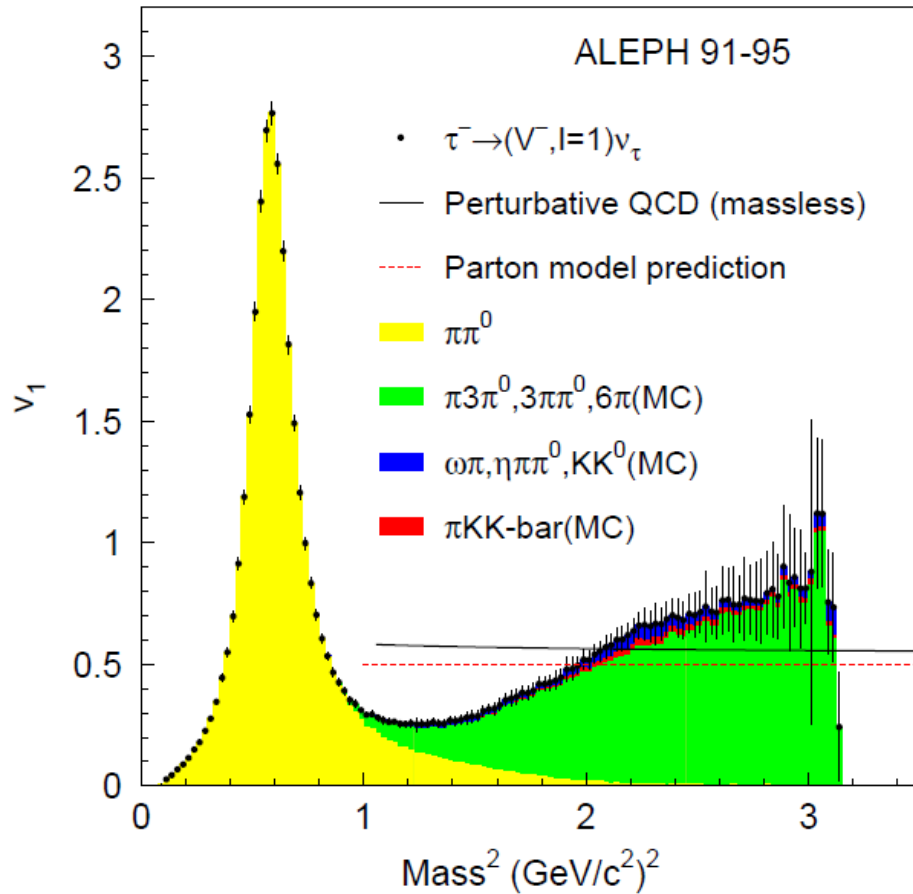

QCD Sum rule

Measurements of axial vector mesons in a medium is difficult.
Different type of sum rule is proposed.

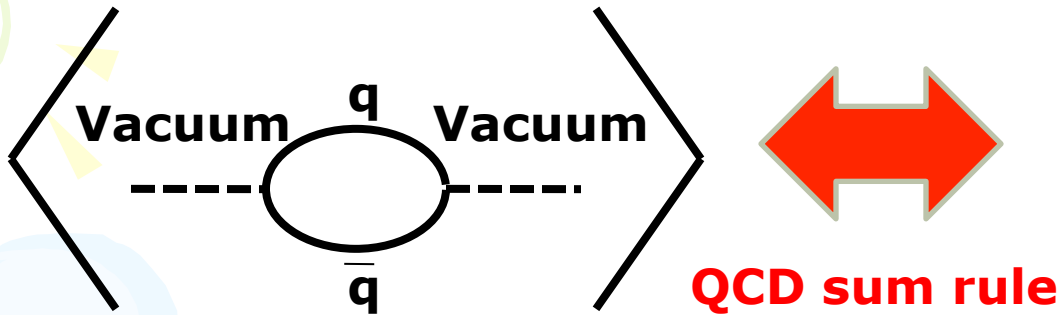

Average of Imaginary
part of $\Pi(\omega^2)$
vector meson
spectral function

Example:

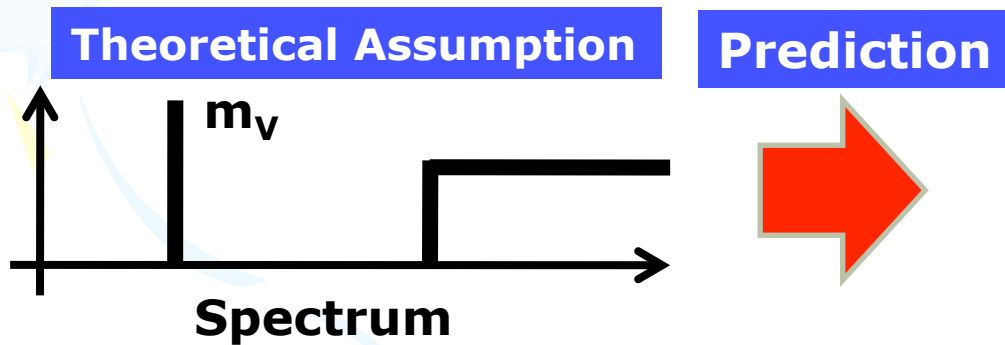

T.Hatsuda and S.H. Lee,
PRC 46 (1992) R34

$$\frac{m_V^*}{m_V} = \left(1 - \alpha \frac{\rho_B}{\rho_0} \right); \alpha \approx 0.03$$

Measurements of vector mesons can be done
in nucleus and high energy collisions.

NA60 Results @ SPS

Muon pair invariant mass in Pb-Pb at $\sqrt{s_{NN}}=19.6$ GeV

PRL 96, 162302 (2006)

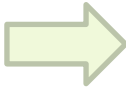
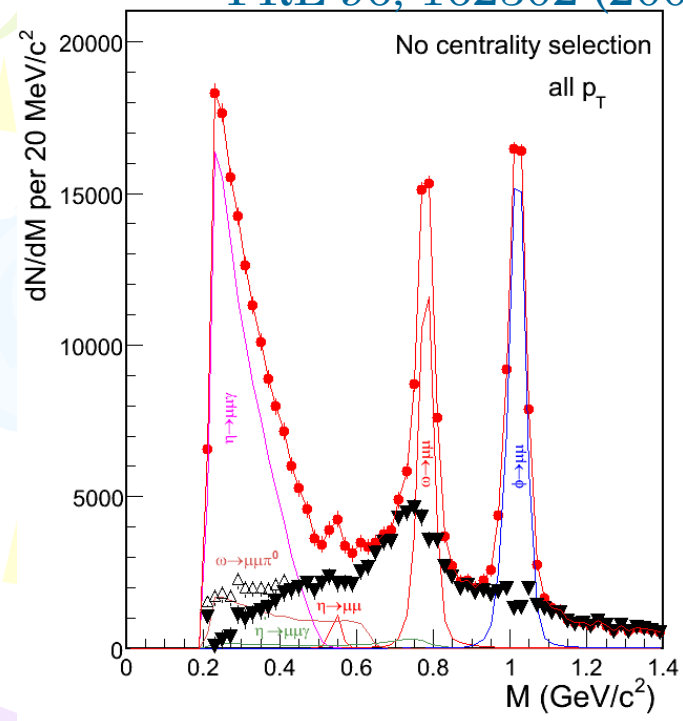

[van Hees+R. Rapp '06]

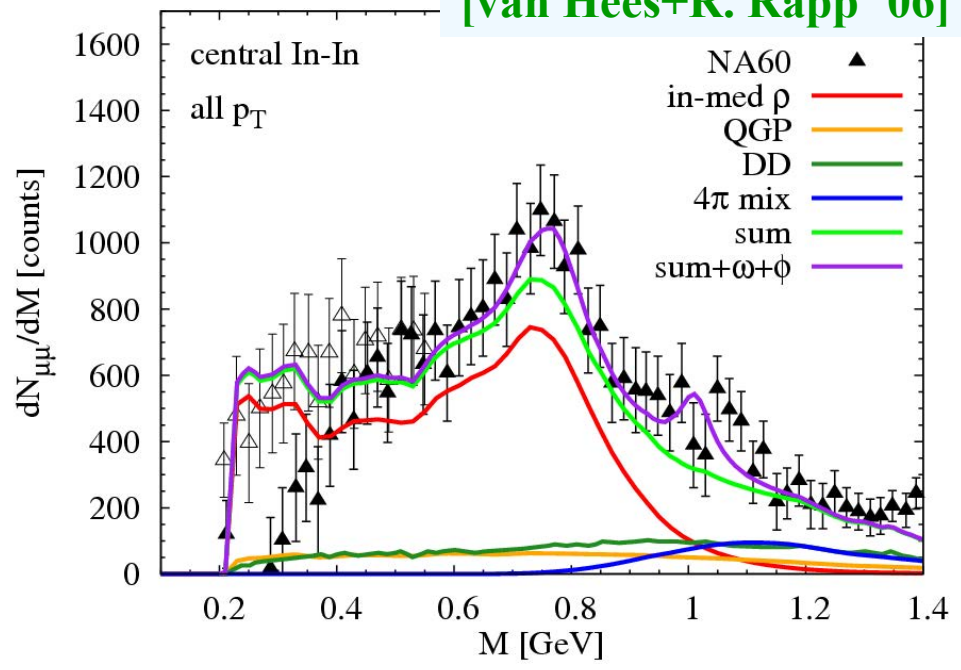

Mass spectra is reproduced by a calculation based on hadron interaction.
Evaluation of condensates should be done.

HADES@GSI

G. Agakishiev et al. Eur.Phys.J. A 48 64 (2012).

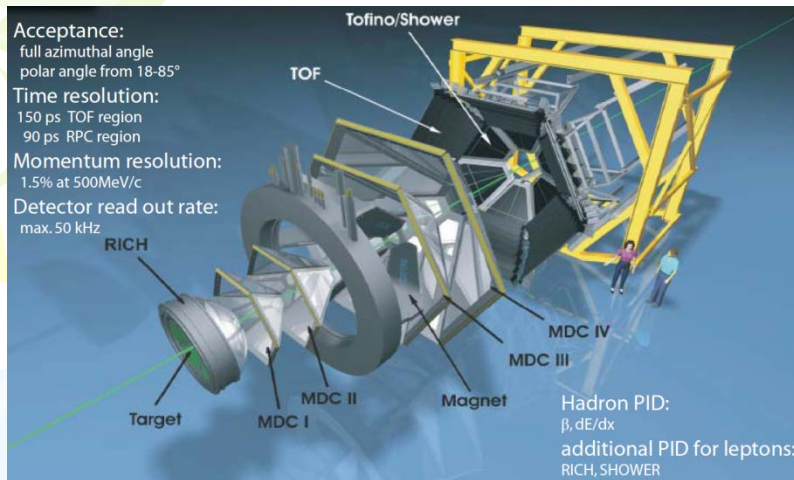

Proton beam
energy at 3.5 GeV

Enhancement both for
p+p and p+Nb?!

They claim effects of
 N^* resonances.

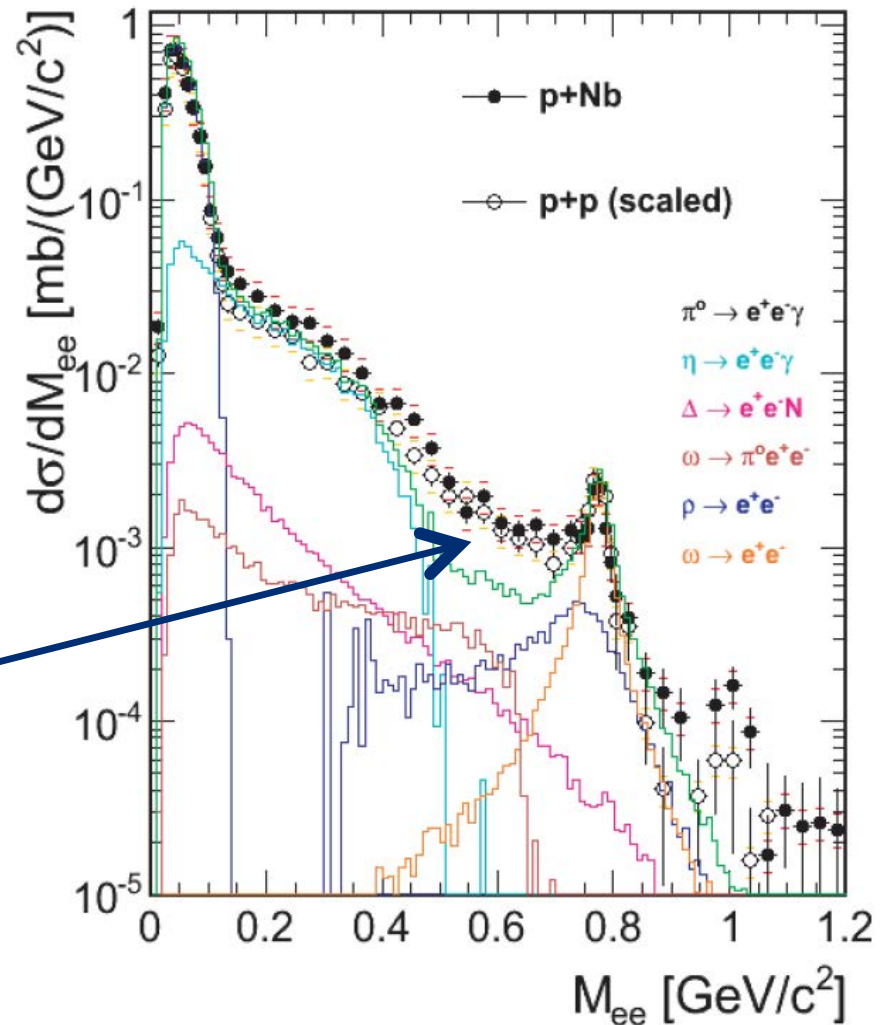

In pA (KEK-PS E325)

12 GeV proton induced.
 $p+A \rightarrow \phi + X$
 Electrons from ϕ decays are detected.

R. Muto et al., PRL 98(2007) 042581

$\beta\gamma < 1.25$ (Slow)

Decays **outside** nucleus

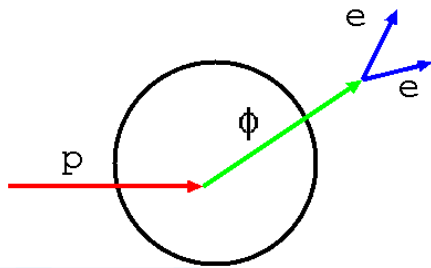

ϕ meson has **NO** mass modification

Blue line shows expected line shape including all experimental effects w/o mass modification

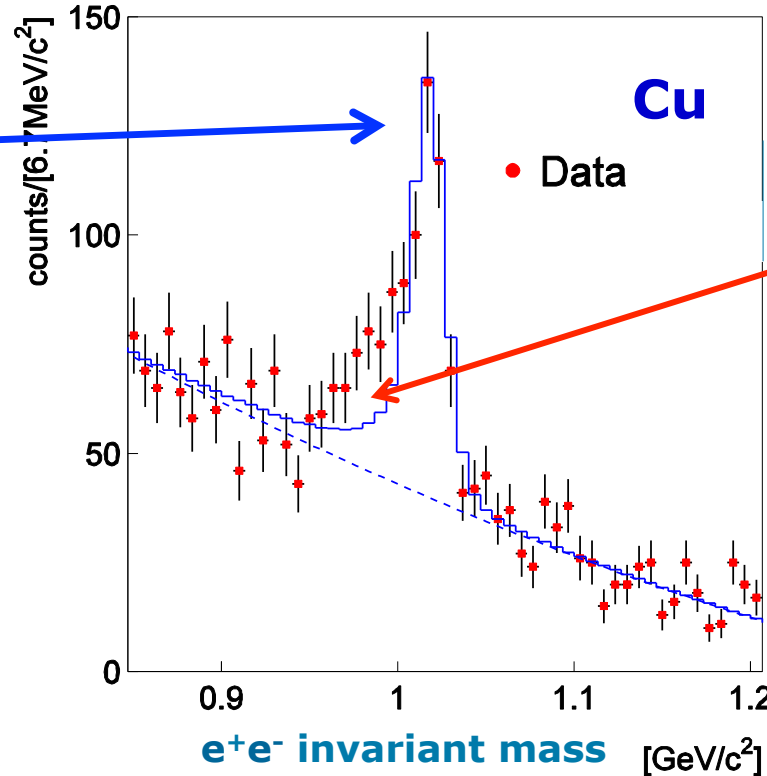

Decays **inside** nucleus

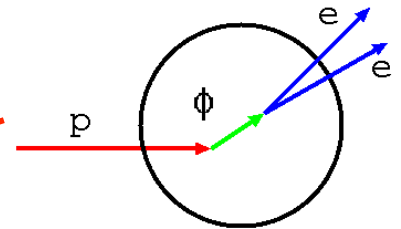

ϕ meson has mass modification

Modification is shown as an **Excess**

Indication of mass modification!

Target/Momentum dep.

$\beta\gamma < 1.25$ (Slow)

$1.25 < \beta\gamma < 1.75$

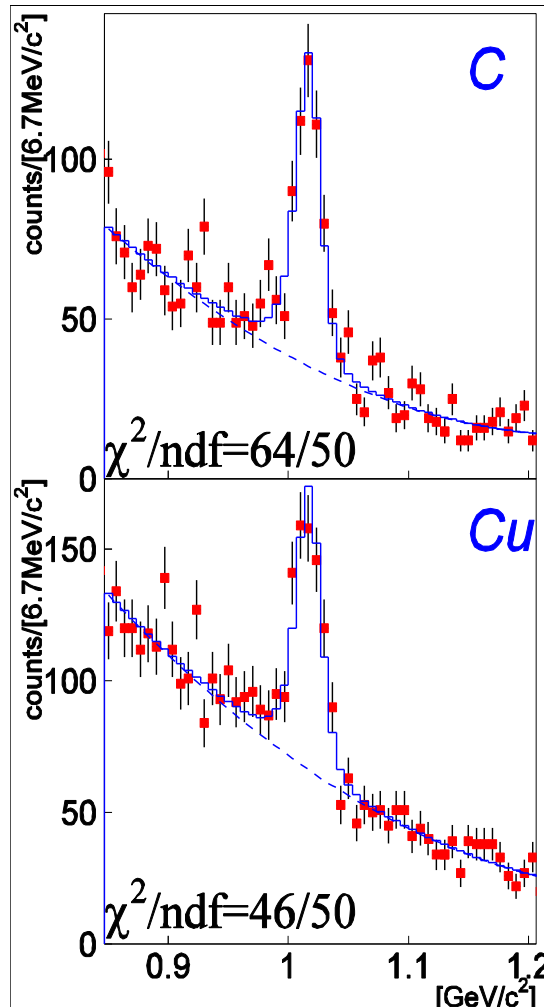
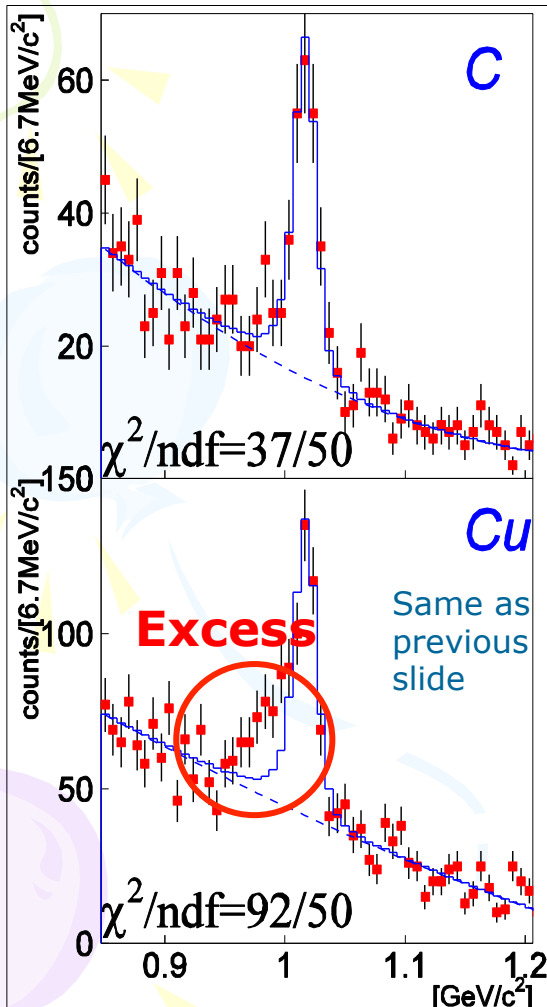

e^+e^- invariant mass

Two nuclear targets:
Carbon & Copper
Inside-decay
increases in **large nucleus**

Momentum bin
Slowly moving ϕ mesons have
larger chance to
decay inside nucleus

Only one momentum
bin shows a mass
modification under the
current statistics.

To see clear mass
modification,
**significantly larger
statistics are required.**

New Goal @ J-PARC

A clear shifted peak needs to be identified to establish QCD-originated effects

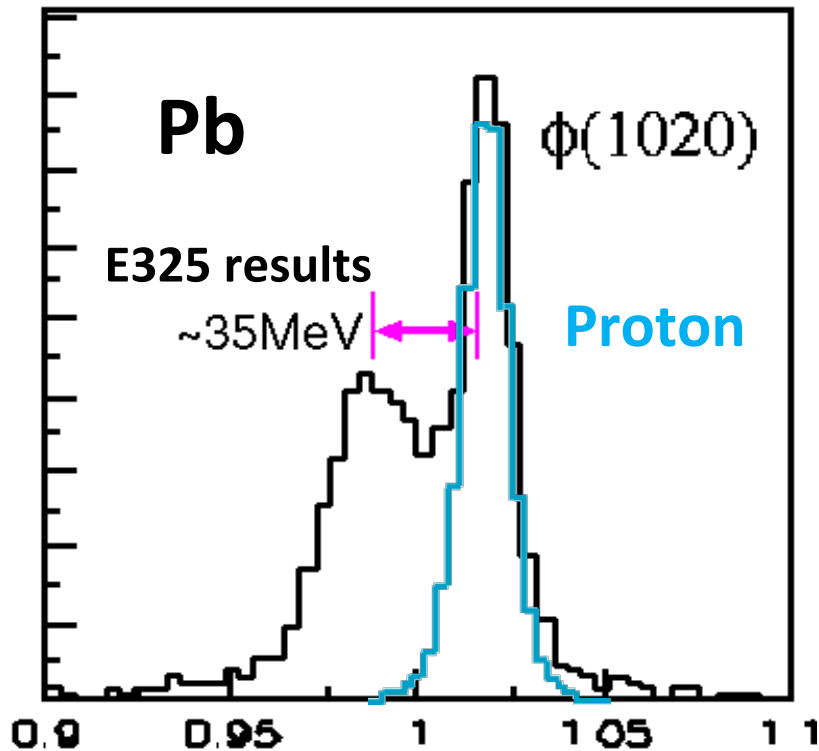

Momentum Dependence

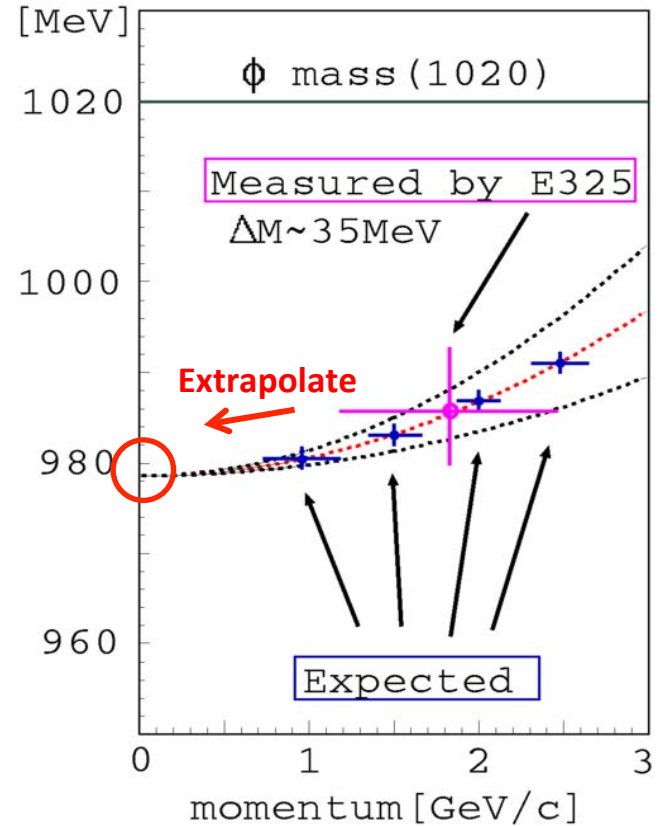

Experimental set up

Construct a new beam line and new spectrometer

Deliver 10^{10} per spill proton beam
Primary proton (30GeV) beam

Cope with 10^{10} per spill beam intensity (x10)
Extended acceptance (90° in vertical) (x5)
Increase cross section (x2)

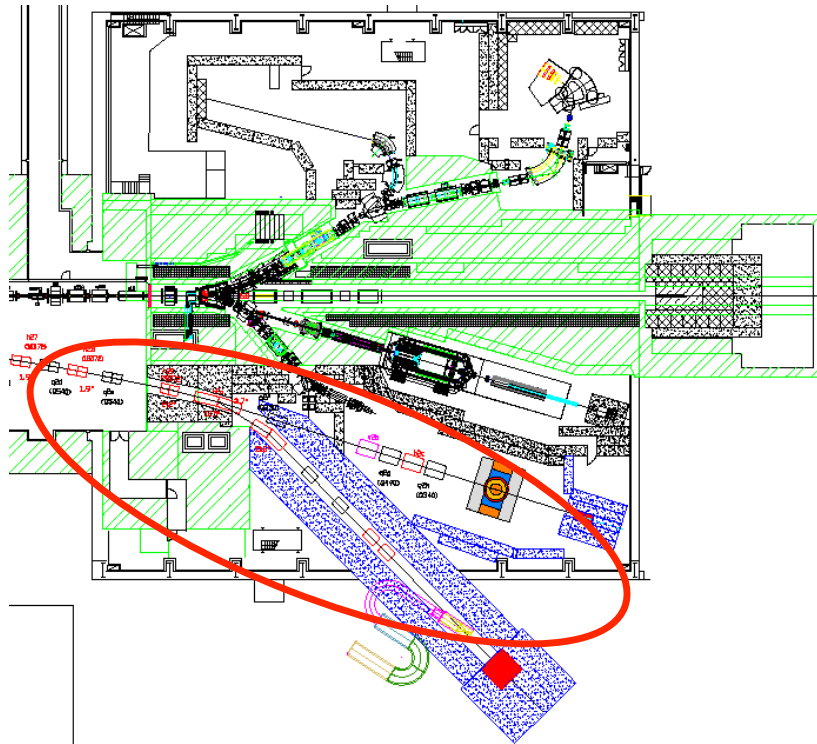

New high momentum beam line

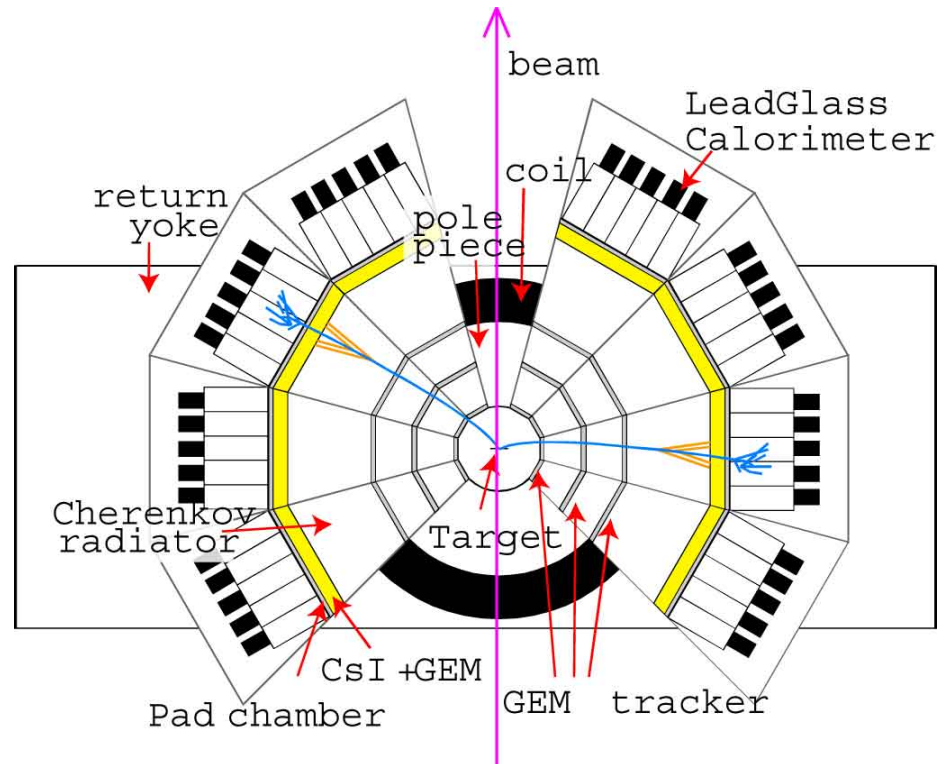

Further physics opportunities

- We are planning to have hadron identification detectors in the spectrometer to extend physics opportunities.
- Cross over between Quark and Hadron
 - Multi-hadron production and Correlation measurements for several energies and reaction systems are important
 - Experimental information of Multi-hadron production in pp and pA reactions are limited
 - Effects of hadron-hadron interactions should be understood in terms of high energy HI physics.
 - When we found an interesting object for our physics, then we should take a comprehensive data. Then, one can figure out what kind of physics have a main role in our data.
- As a future plan, heavy ion beam at J-PARC is under discussion.

Aspects of hadron physics

These aspects are **strongly related**, especially in **interpretations of experimental results**

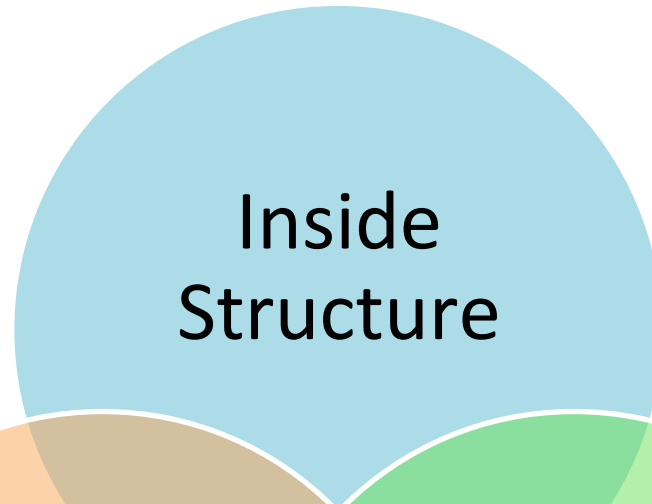

Inside
Structure

Building blocks?
Interaction btw
building-blocks
in hadron

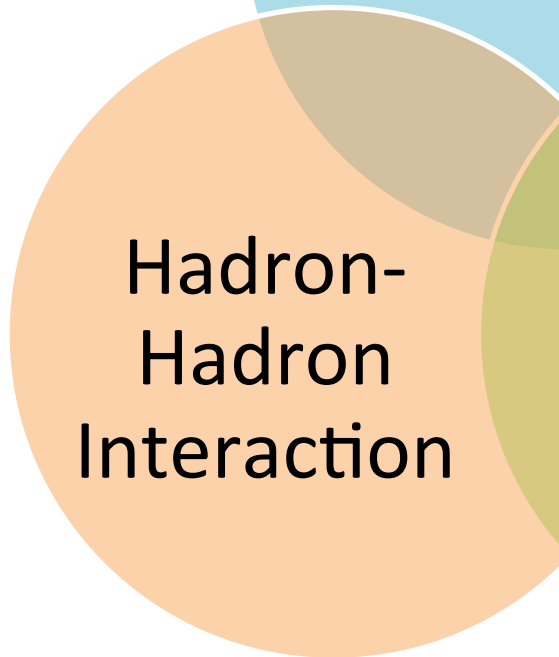

Hadron-
Hadron
Interaction

Interaction btw
“color-less”
particles

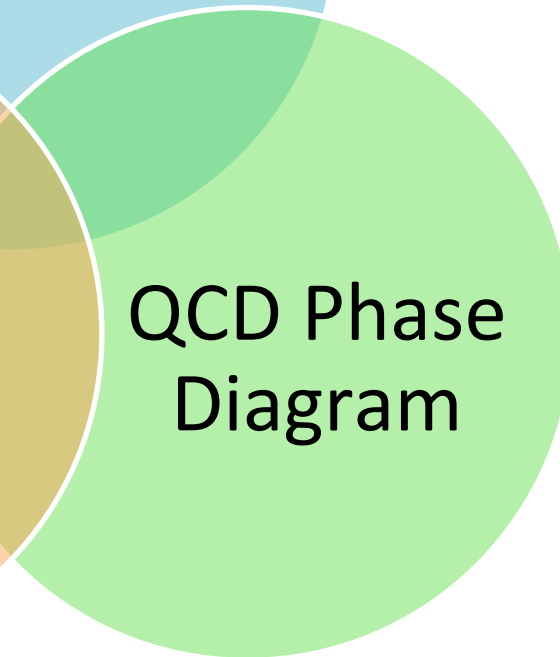

QCD Phase
Diagram

QCD medium
and hadron
properties

Summary

- J-PARC is the nearest experimental facility for hadron physics.
- Chiral properties of QCD medium are studied using measurements of vector meson mass spectra.
- Several measurements are already done using AA and pA collisions to investigate high temperature or high density matters.
- Results show modifications of mass spectra. To study more details of chiral properties, higher statistics and better resolution. Such experiments will be done at J-PARC.

BACKUPS

Chiral symmetry

QCD Lagrangian

$$\mathcal{L} = -\frac{1}{4} F_{\mu\nu}^\alpha F_{\alpha}^{\mu\nu} - \sum_n \bar{q}_n \gamma^\mu [\partial_\mu - ig A_\mu^\alpha t_\alpha] q_n - \sum_n m_n \bar{q}_n q_n$$

Gluon

quark

Divide with
chirality

Neglect mass (if $m \sim 0$)

$$\mathcal{L} = -\frac{1}{4} F_{\mu\nu}^\alpha F_{\alpha}^{\mu\nu} + \bar{q}_L i \not{D} q_L + \bar{q}_R i \not{D} q_R$$

The lagrangian does not change under the transformation below.

$$q_L \rightarrow e^{-i\frac{\vec{\tau}}{2}\vec{\Theta}_L} q_L$$

$$q_R \rightarrow e^{-i\frac{\vec{\tau}}{2}\vec{\Theta}_R} q_R$$

This symmetry is called **Chiral symmetry**.

$V(q)$
Symmetric in rotation

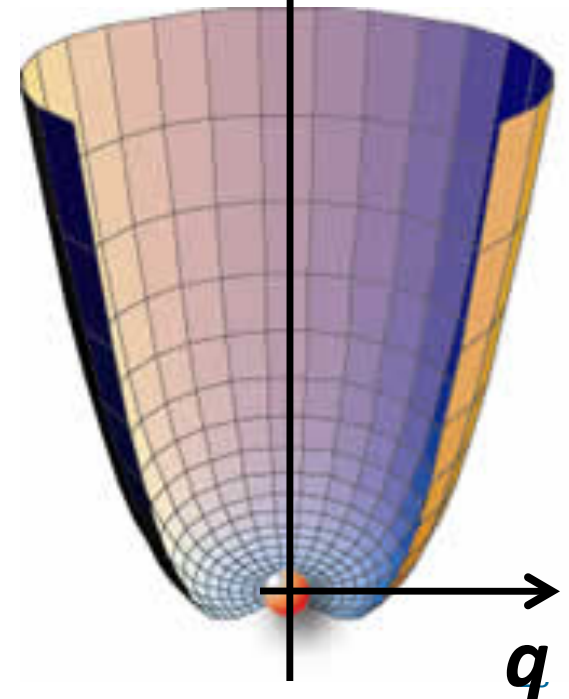

Breaking of symmetry

When the potential is like $V(\phi) = \phi^4$,

Potential is symmetric and
Ground state (vacuum) is at symmetric position

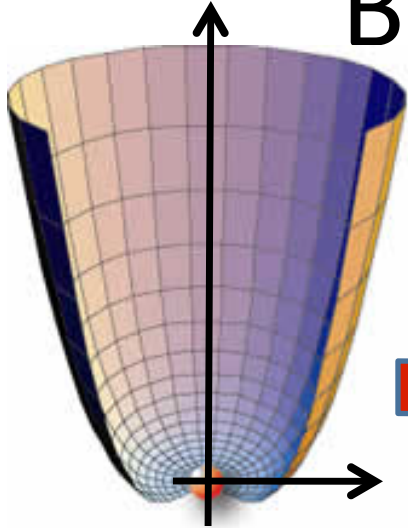

If the interaction generate additional potential
automatically,

$$V'(\phi) = -a*\phi^2$$

Potential is still symmetric, however,
Ground state (vacuum) is at **non-symmetric** position

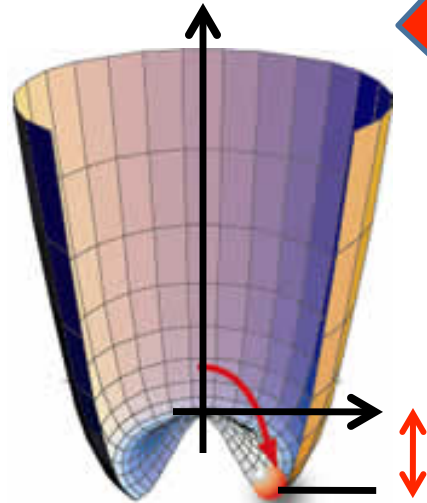

This phenomenon is called
spontaneous symmetry breaking

\sim self energy of ground state \sim mass

In QCD

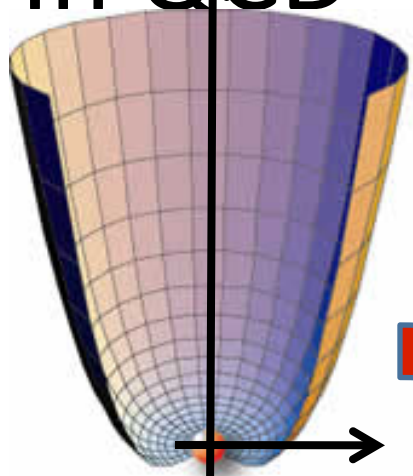

High Temperature
High Density

Chiral symmetry exists.
Mass ~ 0 (Higgs only)

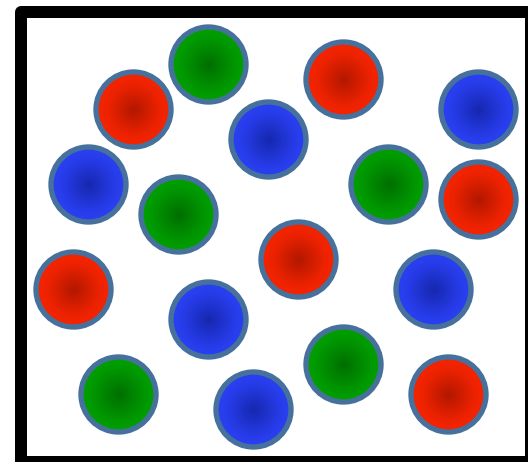

When T and ρ is going down,

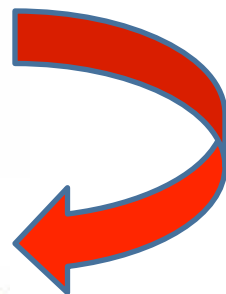

Quark – antiquark pairs make a condensate and give a potential.
Chiral symmetry is breaking, spontaneously.

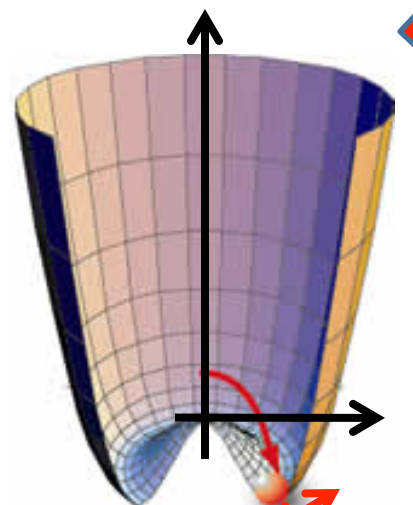
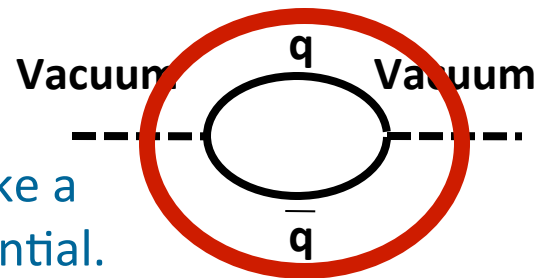

Vacuum contains quark antiquark condensates.
So called "QCD vacuum".

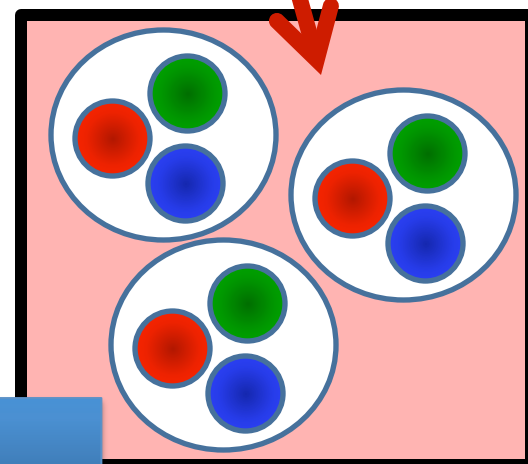

π as a Nambu-Goldstone boson.

How to study more details?

“QCD medium”, i.e. quark condensates can be changed in finite density or temperature matter. Then, chiral symmetry will be restored (partially).

Vacuum
 $\rho \approx 0$

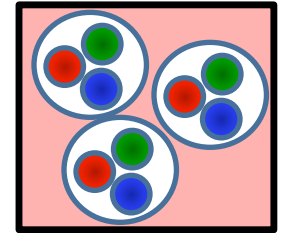
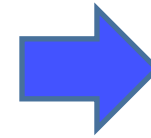

In finite ρ/T

**Chiral properties can be studied
at finite density or temperature.**

**Nucleus can be used as a finite density system.
High energy heavy ion collisions can generate
a high temperature matter**

Chiral property of the medium is characterized by a quark condensate.
The quark condensate is an order parameter of chiral symmetry.

INS-ES TAGX experiment

$E_\gamma \sim 0.8-1.12$.GeV, sub/near-threshold ρ^0 production

- PRL80(1998)241,PRC60:025203,1999.: mass reduced in invariant mass spectra of $^3\text{He}(\gamma, \rho^0)X, \rho^0 \rightarrow \pi^+\pi^-$
- Phys.Lett.B528:65-72,2002: introduced **cos θ analysis** to quantify the strength of rho like excitation
- Phys.Rev.C68:065202,2003. In-medium ρ^0 spectral function study via the **H-2, He-3, C-12** ($\gamma, \pi^+ \pi^-$) reaction.

Try many models, and channels

$\Delta, N^*, 3\pi, \dots$

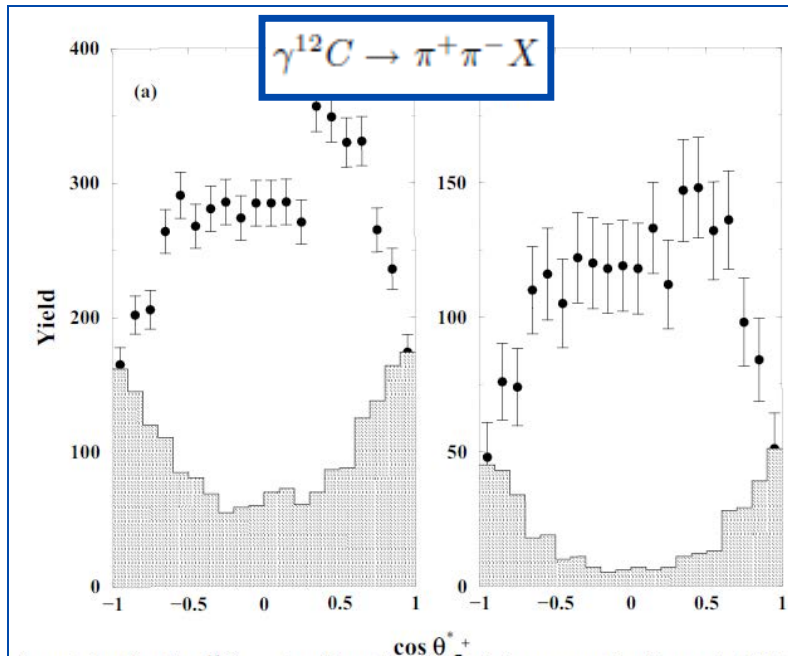

E_γ	STT model Present work	Previous work
800-960 MeV	700-710 MeV	672 ± 31 MeV
960-1120 MeV	730 MeV	743 ± 17 MeV

CLAS g7a @ J-Lab

Induce **photons** to Liquid deuterium, Carbon, Titanium and Iron targets, generate **vector mesons**, and detect **e+e-** decays with large acceptance spectrometer.

R. Nasseripour et al., PRL 99 (2007) 262302

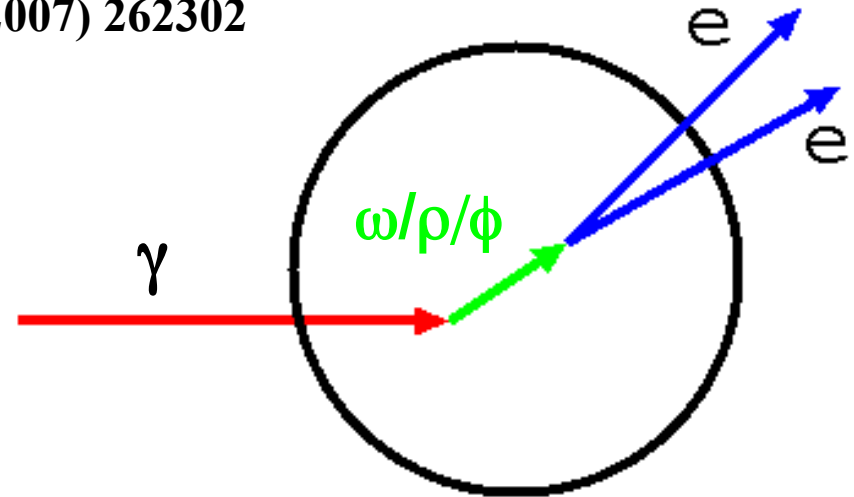
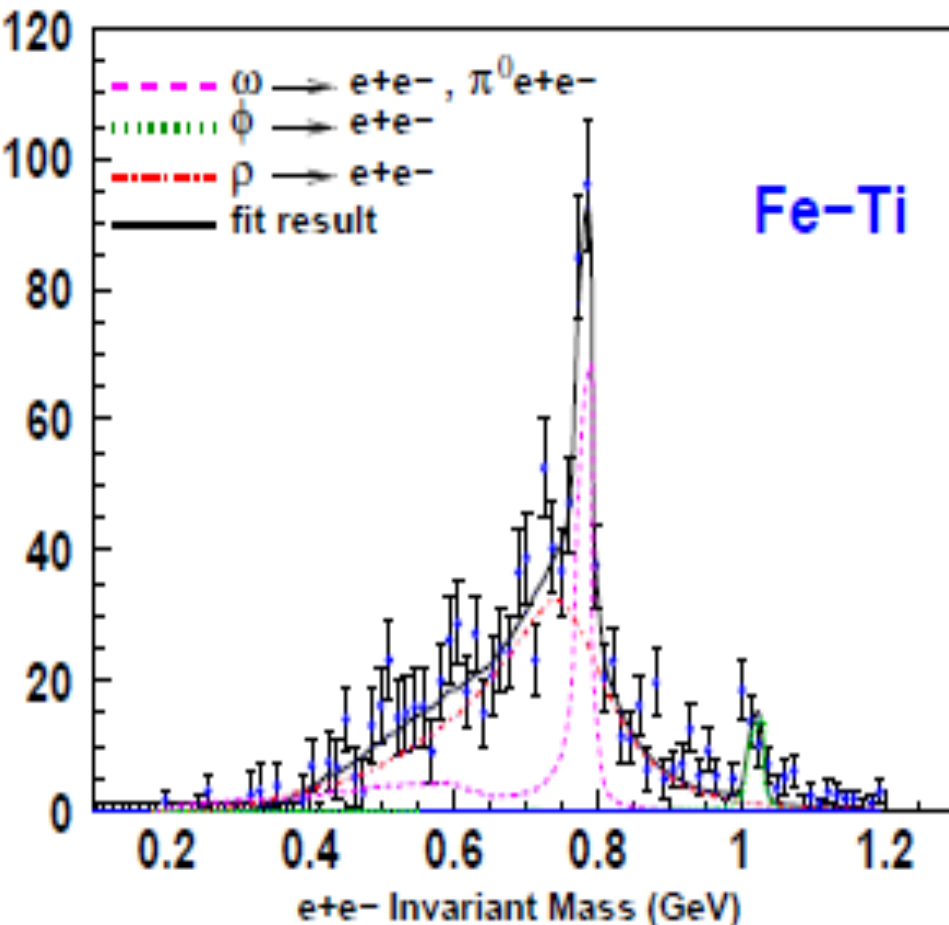

No **peak shift** of ρ

Only broadening is observed

$$m_{\rho} = m_0 (1 - \alpha \rho/\rho_0)$$

for $\alpha = 0.02 \pm 0.02$

Mass spectra measurements

KEK E325, $p/\omega \rightarrow e^+e^-$

Induce **12 GeV protons** to **Carbon and Copper target**, generate vector mesons, and detect **e^+e^- decays** with large acceptance spectrometer.

M. Naruki et al., PRL 96 (2006) 092301

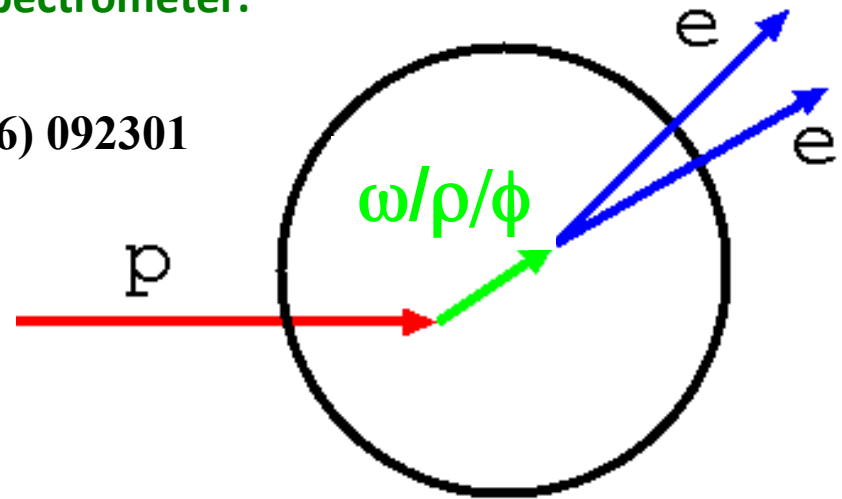
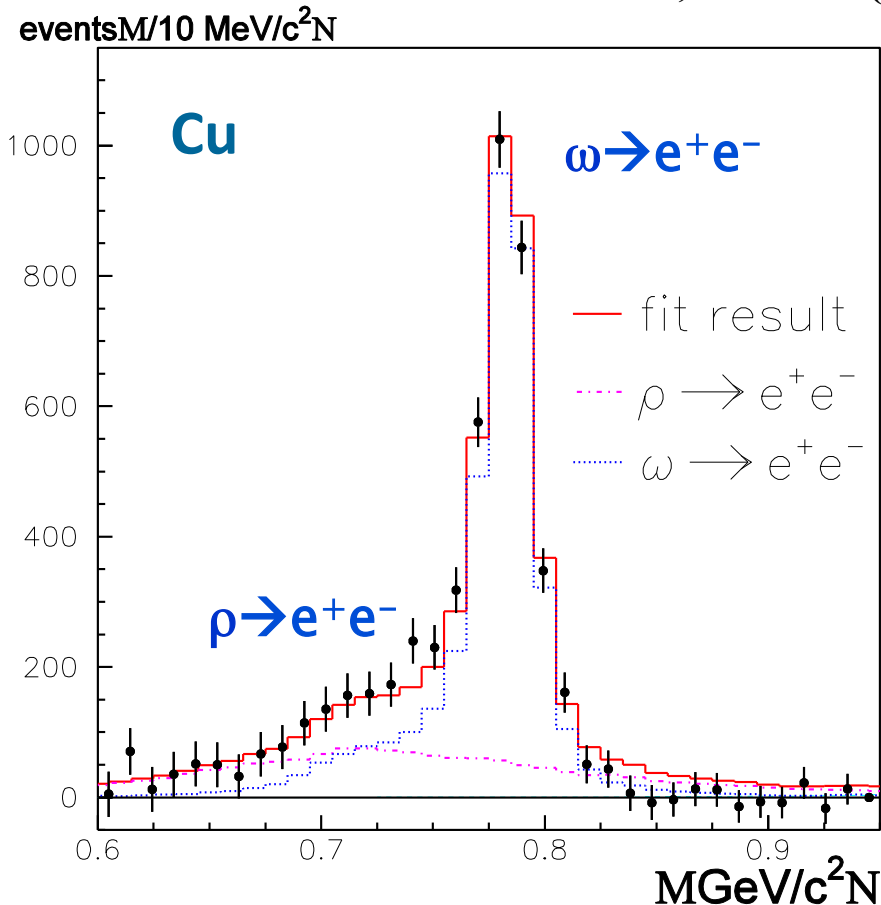

The **excess over the known hadronic sources** on the low mass side of ω peak has been observed.

$$m_\rho = m_0 (1 - \alpha \rho/\rho_0) \text{ for } \alpha = 0.09$$

Results from CBELSA/TAPS

TAPS, $\omega \rightarrow \pi^0\gamma$ with $\gamma+A$

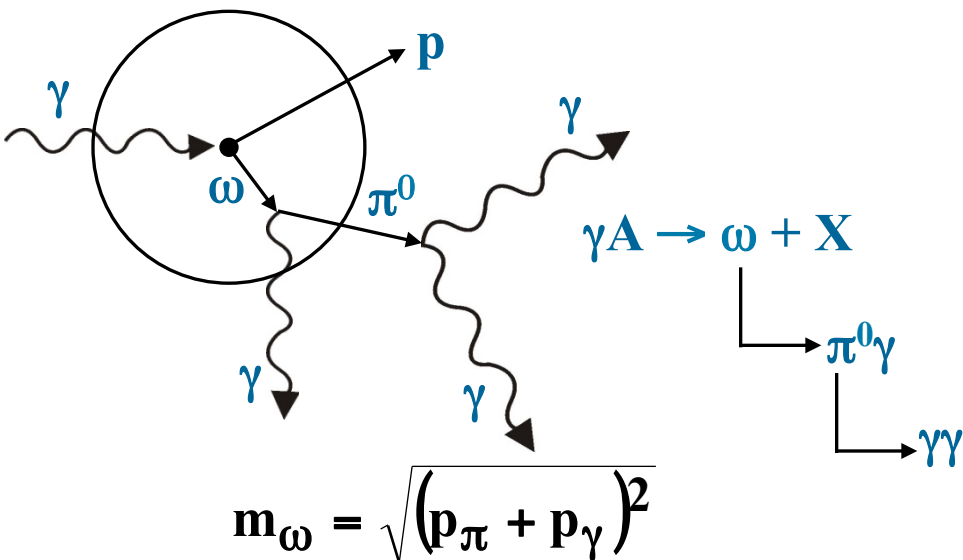

advantage:

- $\pi^0\gamma$ large branching ratio (8 %)
- no ρ -contribution ($\rho \rightarrow \pi^0\gamma : 7 \cdot 10^{-4}$)

disadvantage:

- π^0 -rescattering

arXiv: 1005.5694

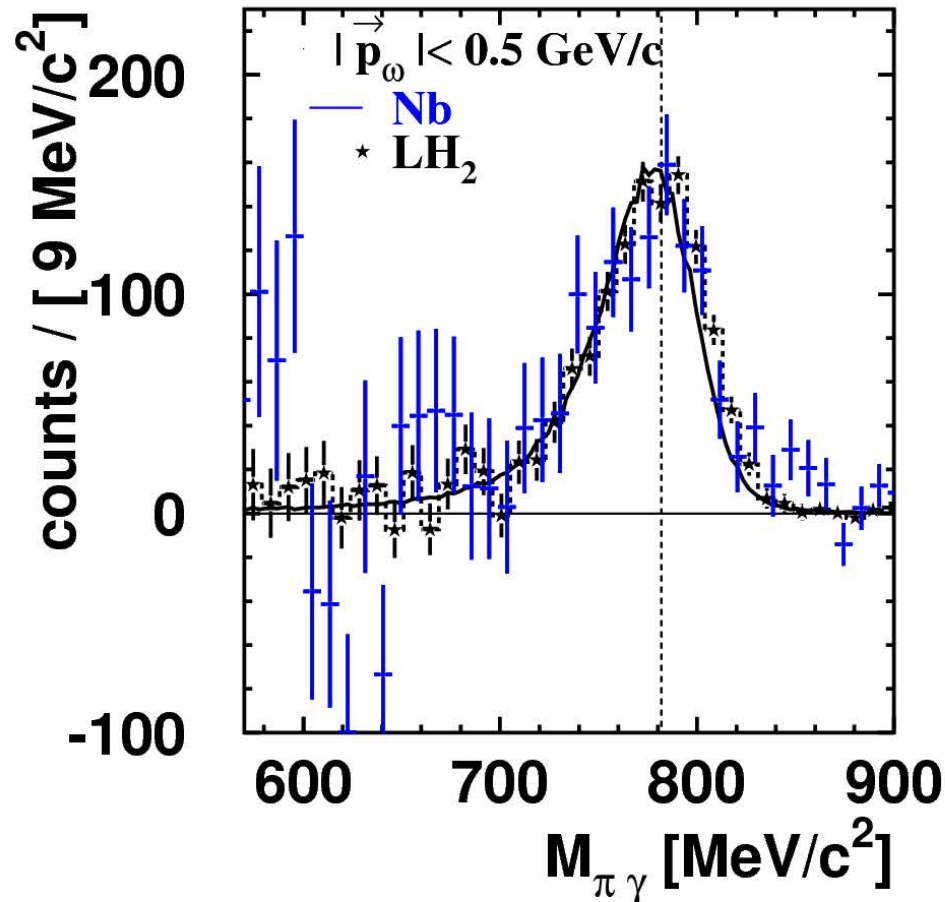

Deeply bound π

Large overlap of wave function

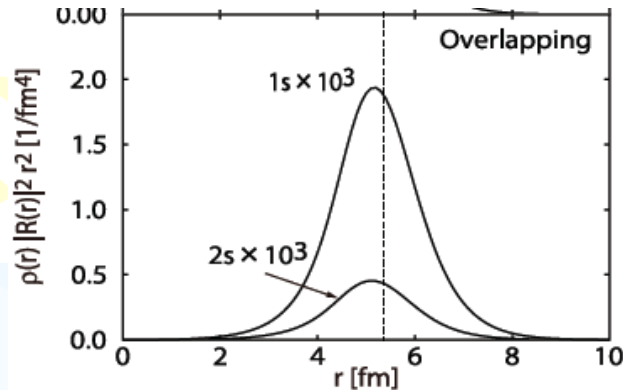

N. Ikeno et al., PTPI26(2011)483.

Daisuke Jido, Tetsuo Hatsuda, Teiji Kunihro, Phys.Lett.B670:109-113,2008.
Kolomeitsev, Kaiser, Weise, Phys. Rev. Lett. 90(2003)092501

M. Gell-Mann et al., PR175(1968)2195.

Gell-Mann-Oakes-Renner relation

$$f_{\pi}^2 m_{\pi}^2 = -2m_q \langle \bar{q}q \rangle$$

f_{π} : pion decay constant

Y.Tomozawa, NuovoCimA46(1966)707.

S.Weinberg, PRL17(1966)616.

Tomozawa-Weinberg relation

$$b_1 = -\frac{m_{\pi}}{8\pi f_{\pi}^2}$$

b_1 : isovector πN scattering length

Sensitive to π -nucleus strong interaction potential

$$V_{s\text{-wave}} = b_0 \rho + \mathbf{b}_1 (\rho_n - \rho_p) + B_0 \rho^2$$

Measure binding energy can be converted to this b_1 information

$$\frac{\langle \bar{q}q \rangle_{\rho}}{\langle \bar{q}q \rangle_0} \approx \frac{b_1^{\text{free}}}{b_1(\rho)}$$

Exp. Results

K. Suzuki et al., Phys. Rev. Let., 92(2004) 072302

π bound state is observed in Sn(d, ^3He) pion transfer reaction at GSI.

Reduction of the chiral order parameter, $f_{\pi}^*(\rho)^2/f_{\pi}^2=0.64$ at the normal nuclear density ($\rho = \rho_0$) is indicated.

Experiment is continued at RIKEN and positive results are already obtained.

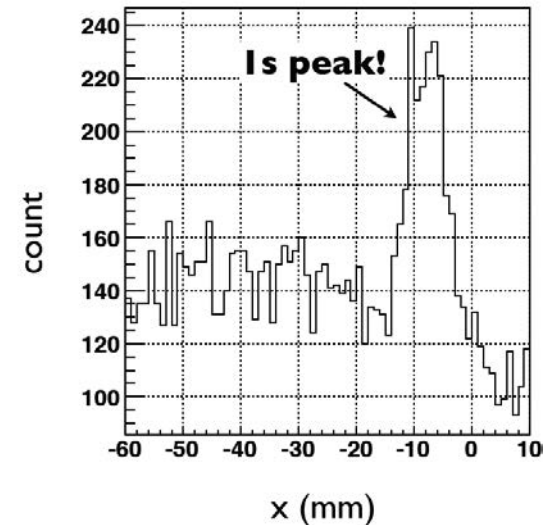
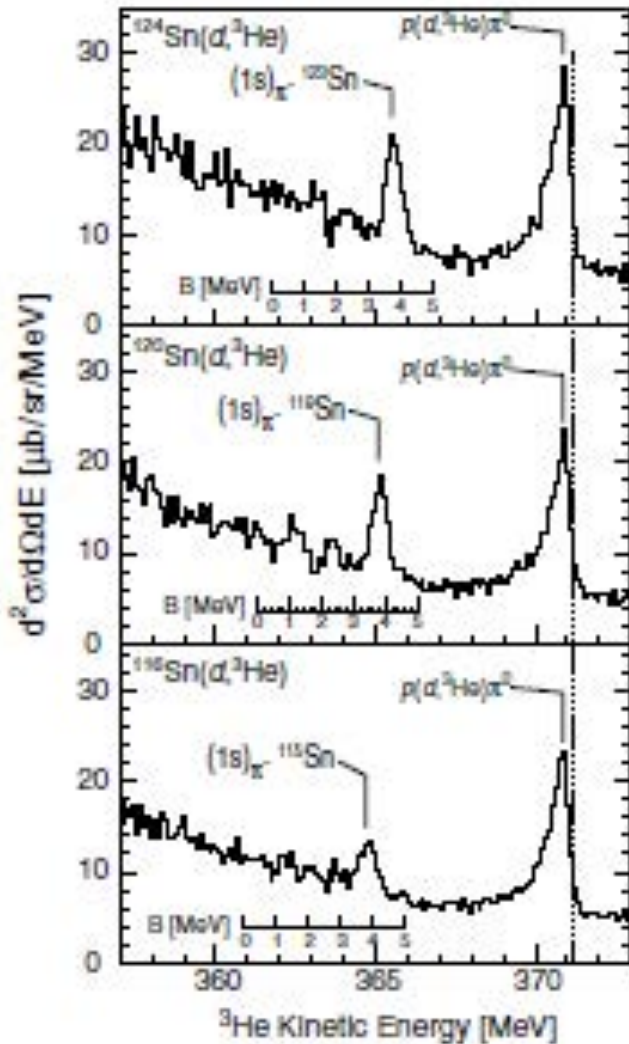

Current status of experiments

Most measurements are done for ρ/ω mesons

- High energy heavy ion collisions
 - SPS-NA60 (PRL 96 (2006) 162302)
 - Modification of ρ meson due to hadronic effects
 - RHIC-PHENIX (PRC81(2010) 034911)
 - Origin of the enhancement is under discussion
- Nuclear targets
 - CBELSA/TAPS (Phys.Rev. C82 (2010) 035209)
 - Modification of ω is not observed
 - J-LAB CLAS G7 (PRL 99 (2007) 262302)
 - Mass broadening of ρ due to hadronic effects
 - KEK-PS E325 (PRL 96 (2006) 092301)
 - Peak shift and width broadening of ρ/ω

**Large
uncertainty
in
background**

Several hadronic and experimental effects cause

How about ϕ meson?

- ρ/ω
 - Dynamical mass contribution is dominant
 $M_\pi \sim 130 \text{ MeV}/c^2$ $M_\rho \sim 770 \text{ MeV}/c^2$
 - Large hadronic effects and background issues are large
- ϕ
 - Still, dynamical mass contribution is dominant
 $M_\eta \sim 550 \text{ MeV}/c^2$ $M_\phi \sim 1020 \text{ MeV}/c^2$
 - Narrow width ($4.3 \text{ MeV}/c^2$)
 - Small background issue
 - **Small effects of hadron-hadron interactions**
 - e.g. Binding energy of ϕN is 1.8 MeV (Phys. Rev. C 63(2001)
022201R)

To see QCD-originated effects, ϕ meson is the most prom

Experimental Setup

12 GeV proton induced.



Electrons from ϕ decays are detected.

KEK E325

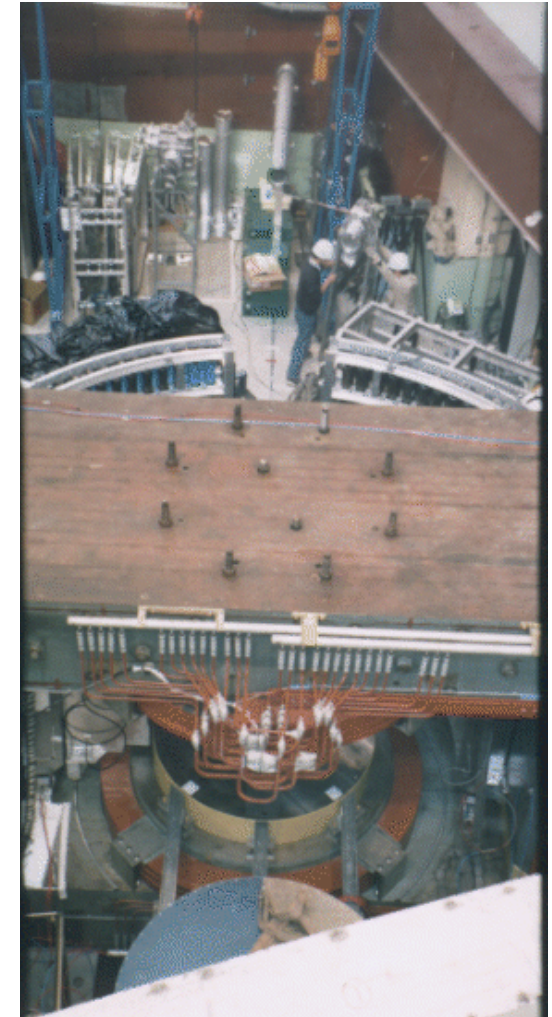
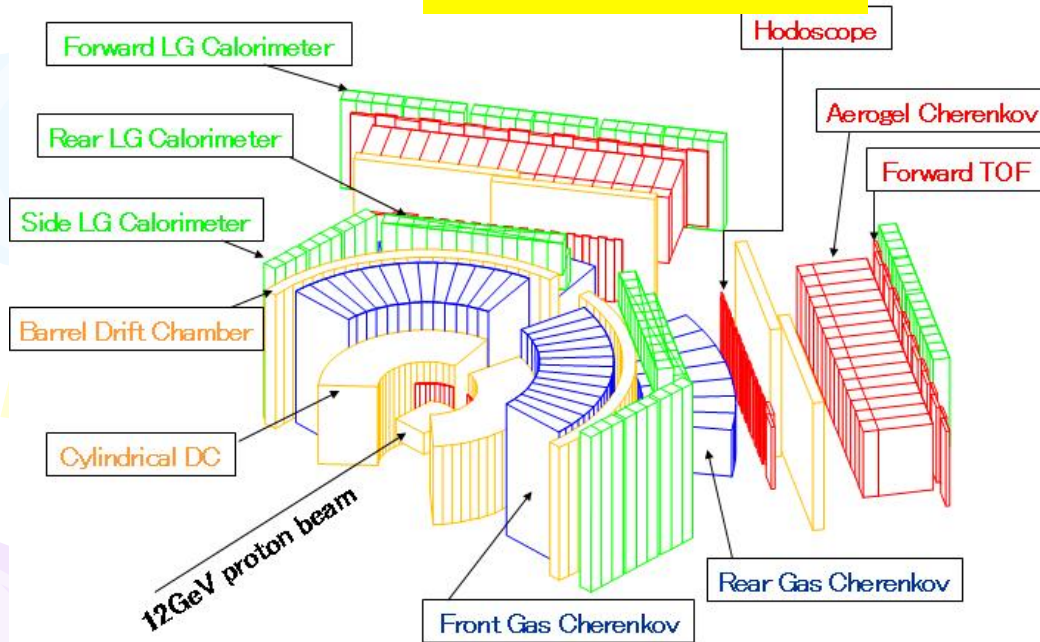

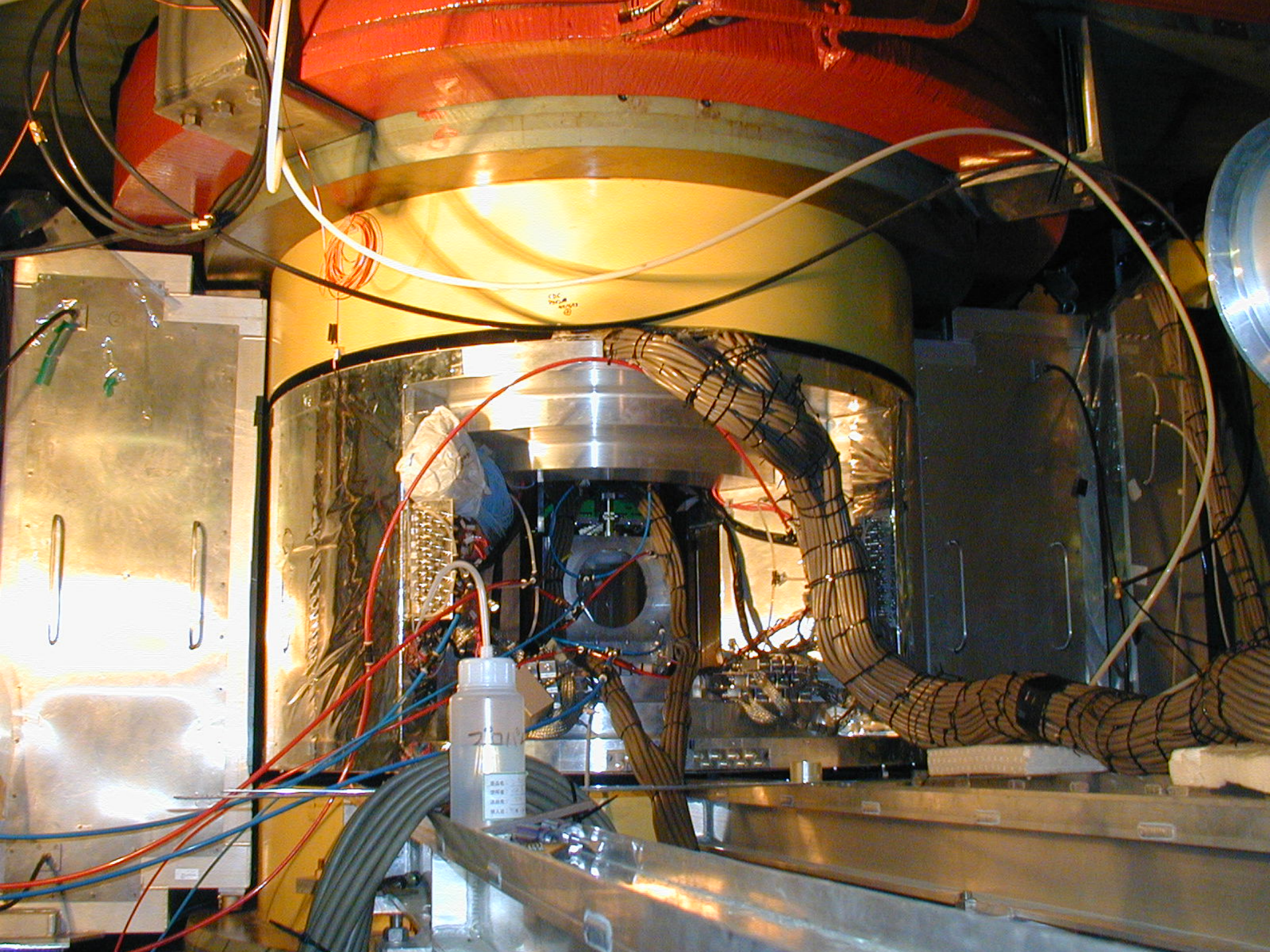

Next step

Evaluate quark condensate directly.

Average of Imaginary part of $\Pi(\omega^2)$

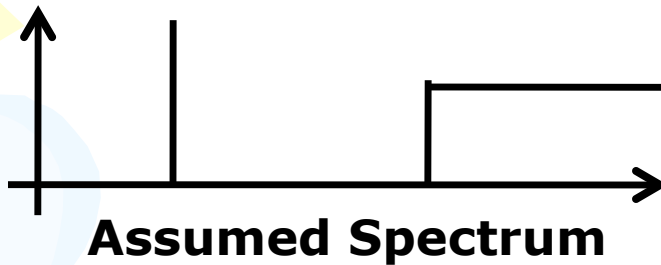

Replace by average of measured spectra

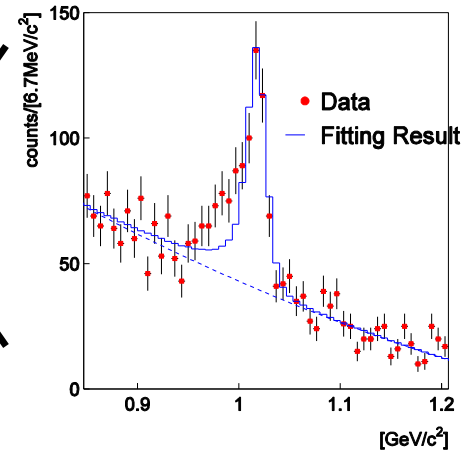

Then, calculate quark condensate using QCD sum rule.

Experimental requirements

1. High statistics
2. Good mass resolution

What can be achieved?

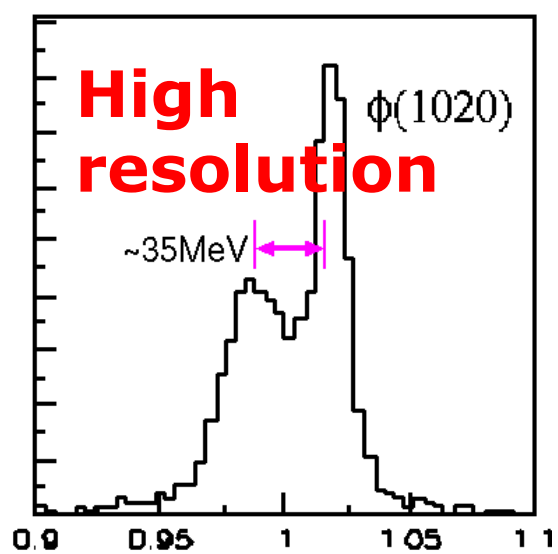
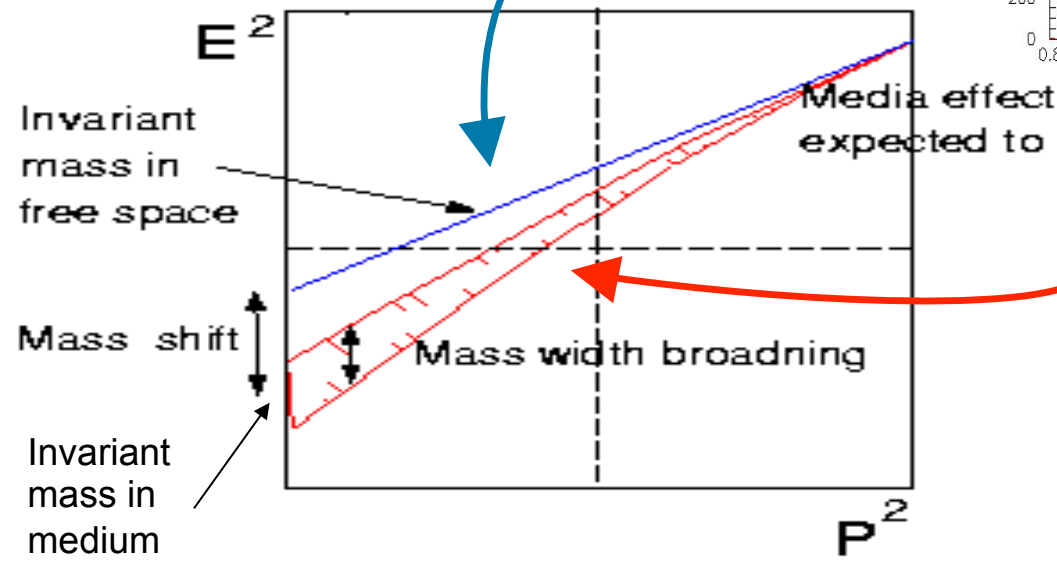
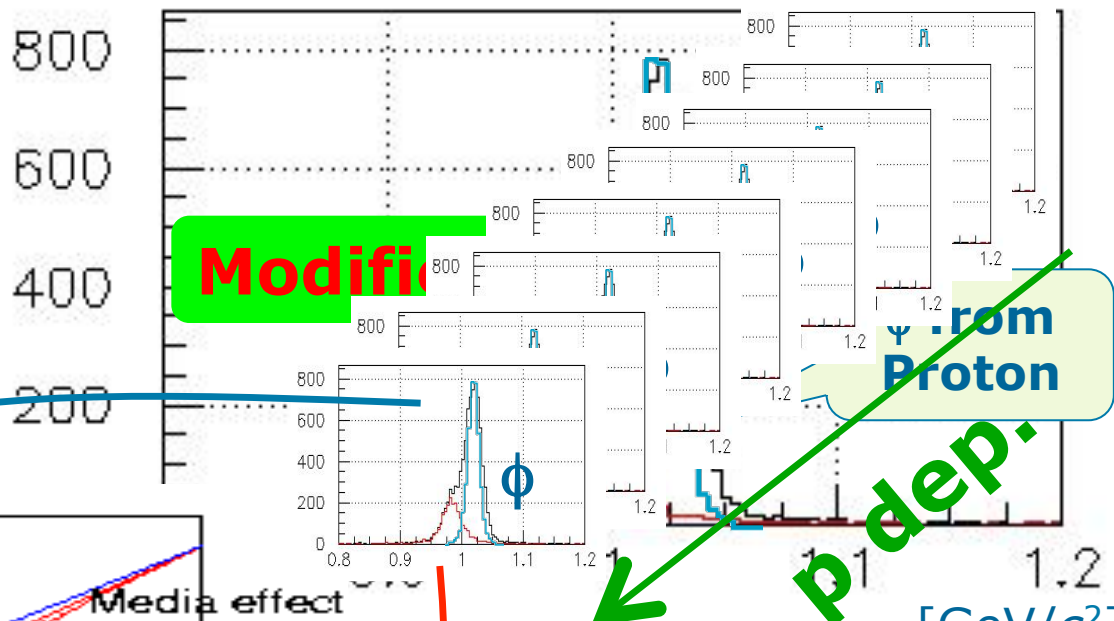
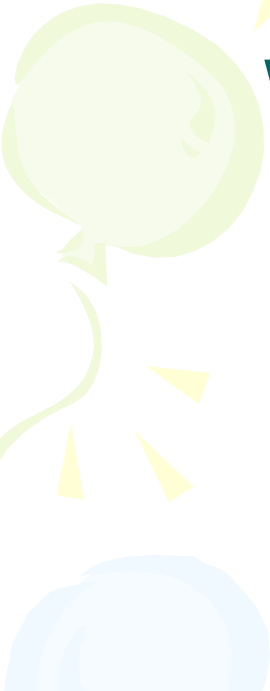

2015/3/1 **Dispersion relation** E workshop

Calc. with other models

$\beta\gamma < 0.5$

$0.5 < \beta\gamma < 1.25$

$\beta\gamma < 0.5$

$0.5 < \beta\gamma < 1.25$

E325
 $\Delta m : 35 \text{ MeV}$
 (28 ~ 41)
 $\Gamma : 15 \text{ MeV}$
 (10~23)

Cu

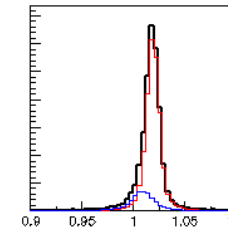
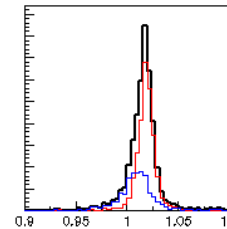
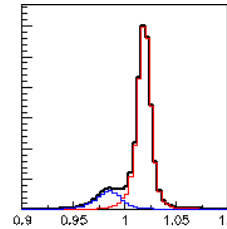
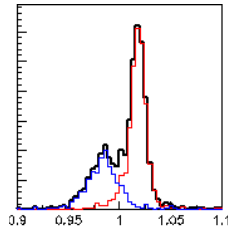

Oset, Ramos
 (NPA 679, 616)
 $\Delta m : 10 \text{ MeV}$
 $\Gamma : 15 \text{ MeV}$

Hadronic model

Pb

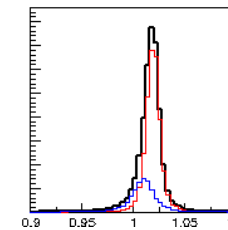
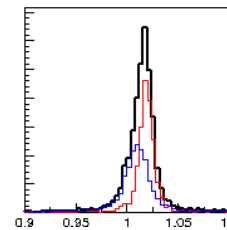
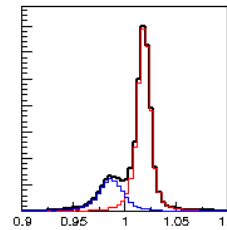
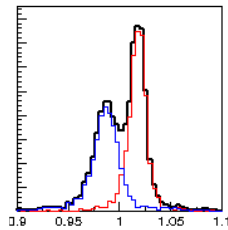

cf. Hatsuda, Lee (PRC46, 34)
 $\Delta m : 12 \sim 44 \text{ MeV}$
 $\Gamma : \text{not estimated}$

 $\Delta m : 35 \text{ MeV}$
 $\Gamma : 50 \text{ MeV}$

Cu

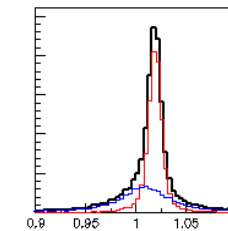
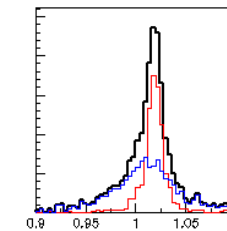
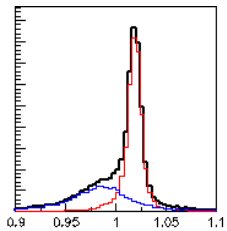
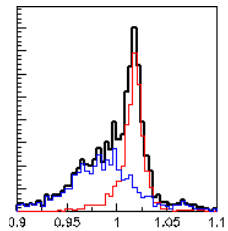

Klinge, Waas,
 Weise
 (PLB431,254)
 $\Delta m : 10 \text{ MeV}$
 $\Gamma : 50 \text{ MeV}$

Hadronic model

Pb

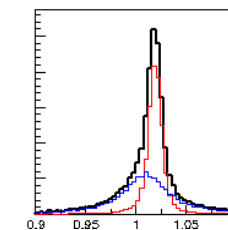
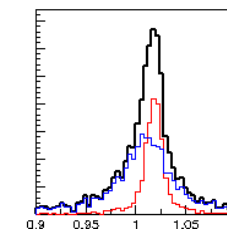
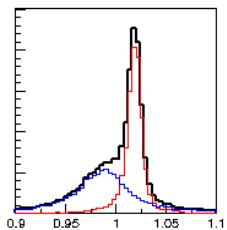
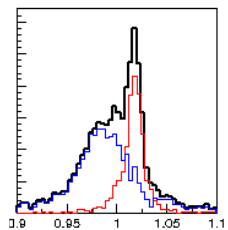

blue: decays inside nuclei

red: decays outside nuclei

At J-PARC, clear mass spectra in nucleus will be obtained to compare with models.

① GEM foil

② GEM Tracker

R&D Items

Develop 1 detector unit and make 26 units.

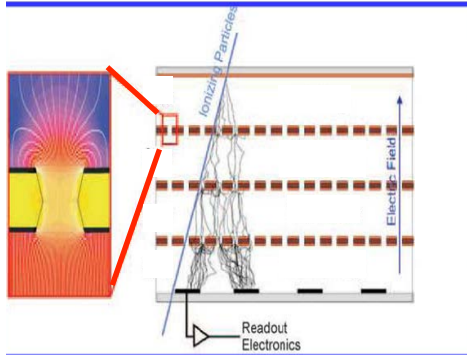
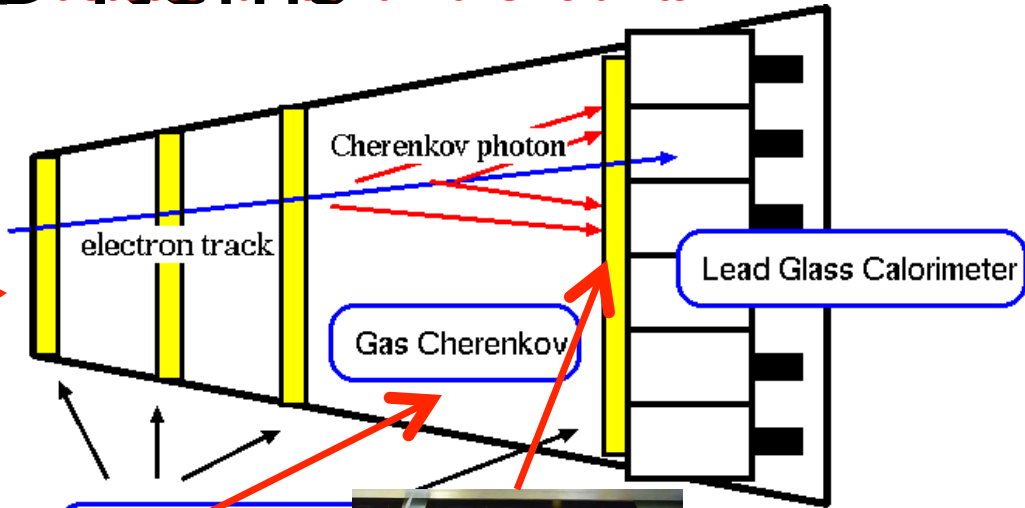
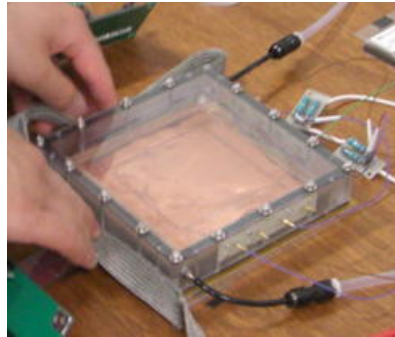

Ionization (Drift gap)
+ Multiplication (GEM)
High rate capability
+ 2D strip readout

GEM Tracker/Photo

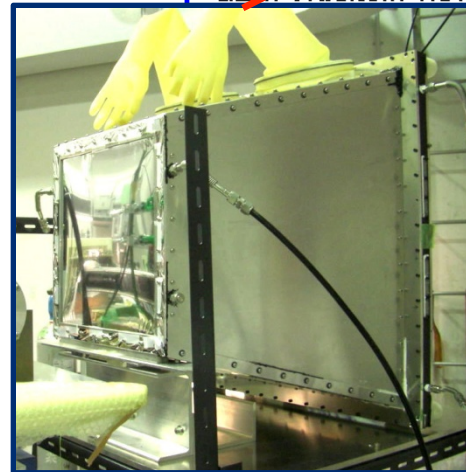

CsI + GEM
photo-cathode

50cm gas(CF₄) radiator
~ 32 p.e. expected
CF₄ also for multiplication in
GEM

③ Hadron Blind detector

Gas Cherenkov for electron-ID

Detector components

Tracker

- ~Position resolution 100 μ m
- High Rate(5kHz/mm²)
- Small radiation length (~0.1% per 1 chamber)

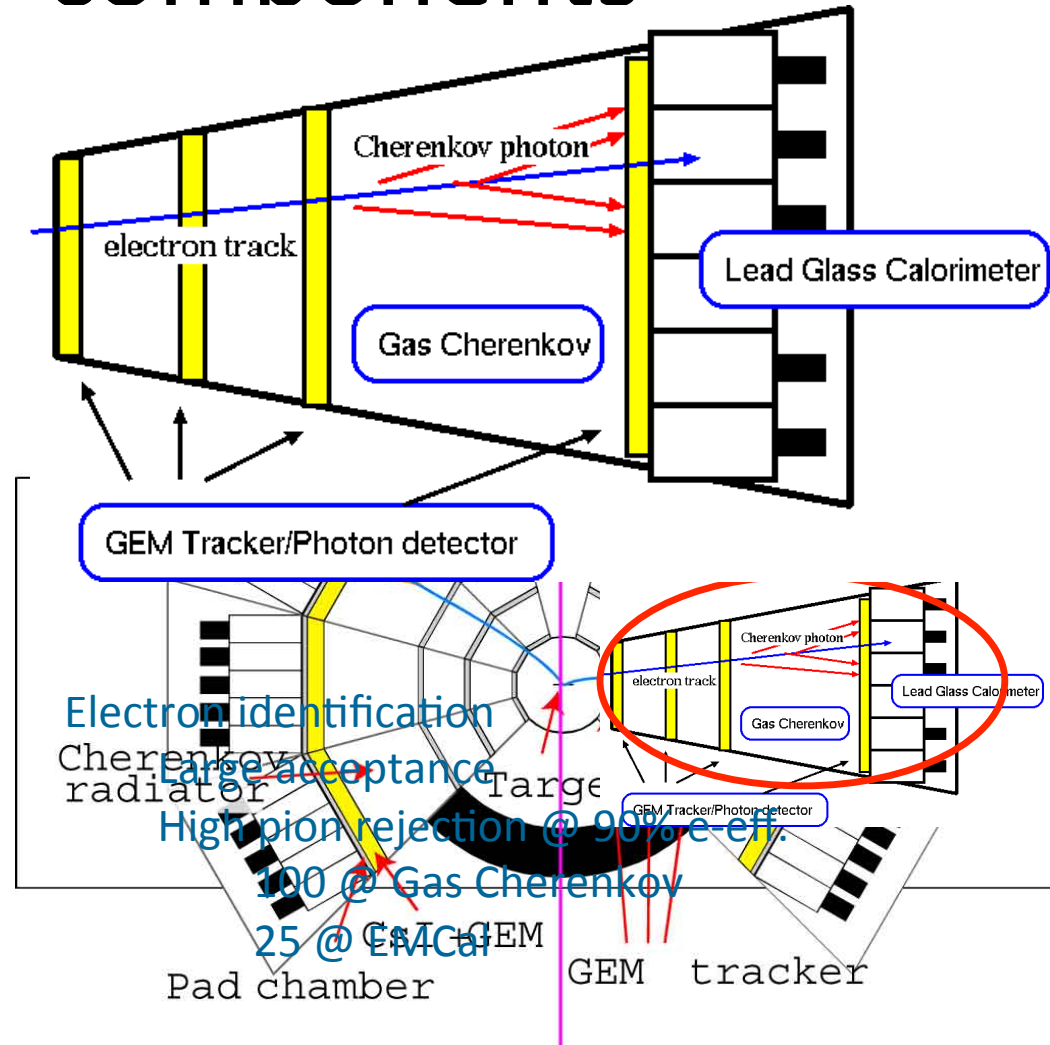
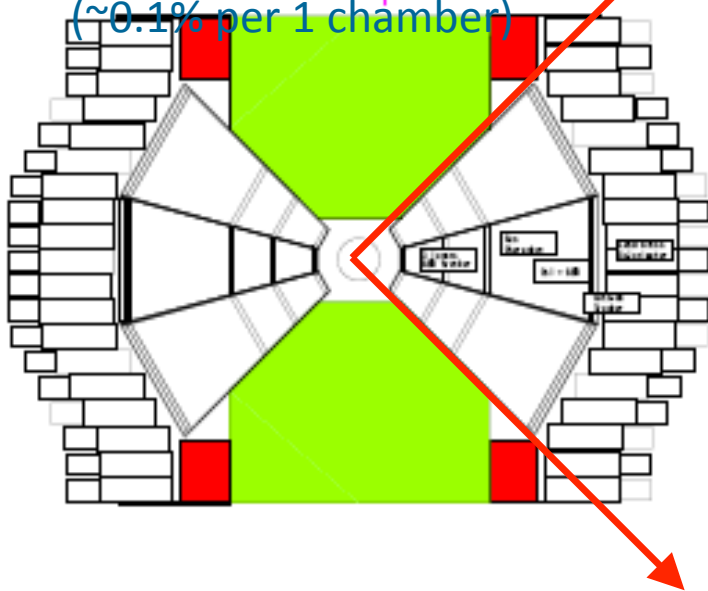

Beam test results of prototype detectors (2012)

GEM Tracker

HBD (Hadron-Blind Cherenkov detector)

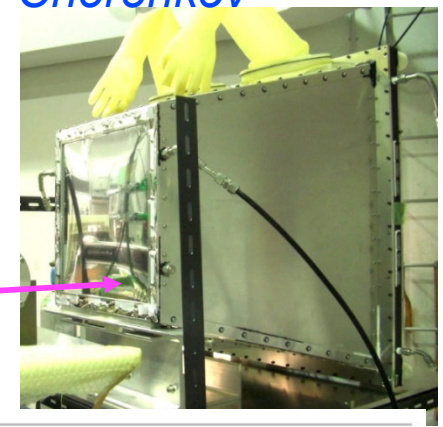
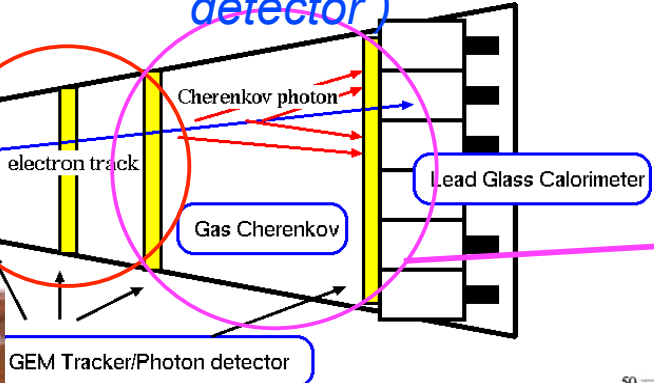
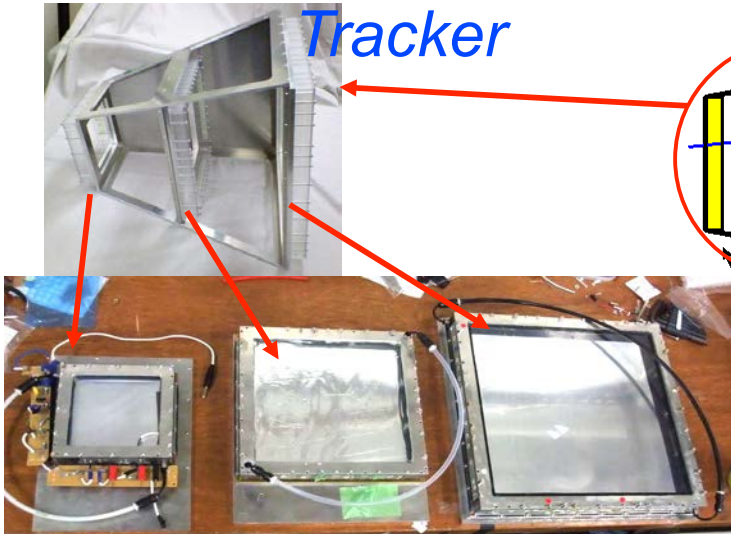

100x100 200x200 300x300

Required position resolution ($\sim 100\mu\text{m}$) is achieved

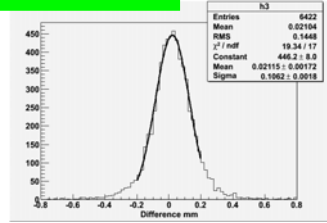

UV Cherenkov photons are detected with CsI-evaporated LCP-GEM and CF_4 gas

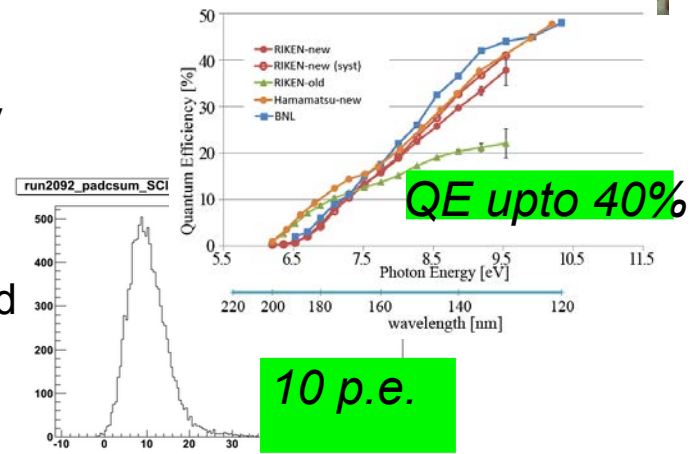

- Large size (300x300mm) PI- and LCP-GEM are successfully worked for a electron beam
 - Stability and response for a pion beam should be checked at J-PARC.
- GEM Tracker is successfully worked.
- Improvement of the photo-detection efficiency of HBD is on going.

GEM Tracker : first prod. type is tested

Y.Komatsu, NIM A 732(2013)241

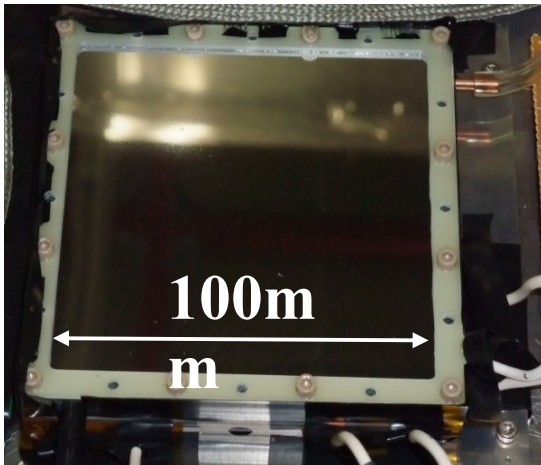

islands for
Y-strip
(Ni plated) Y-strip

200 μ m

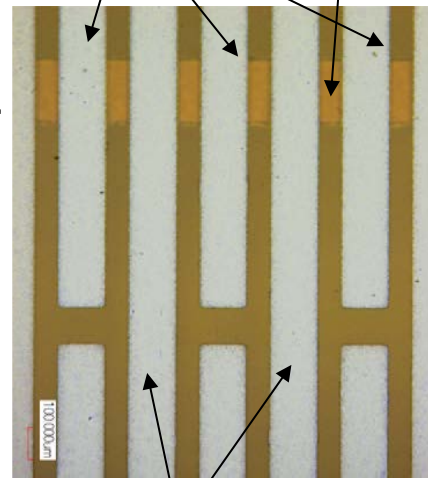

X-strip 125 μ m
(Ni plated)

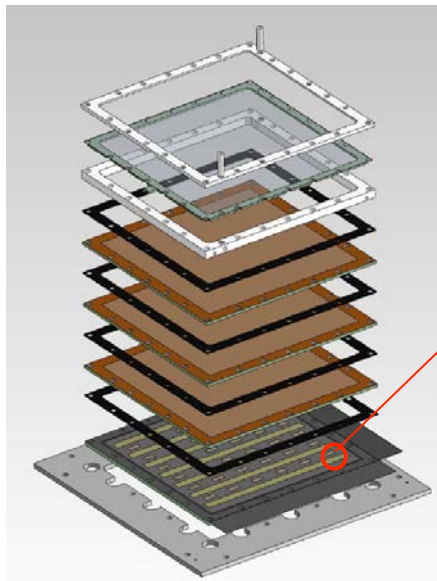
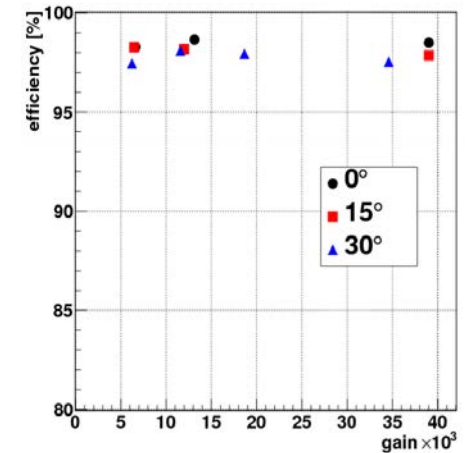
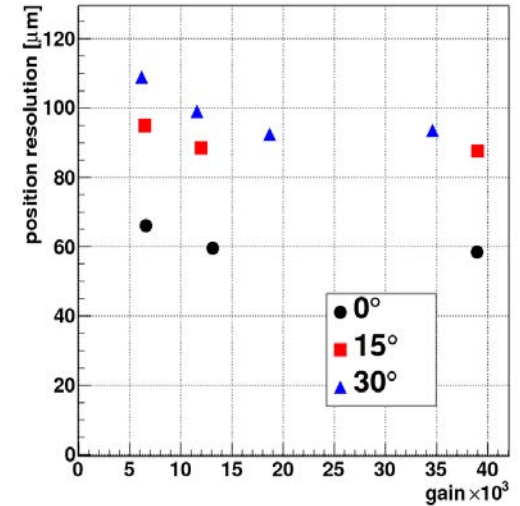
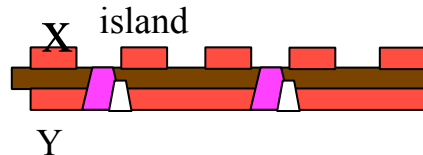

BVH type 2D R/O PCB

HRD @ I-PARC

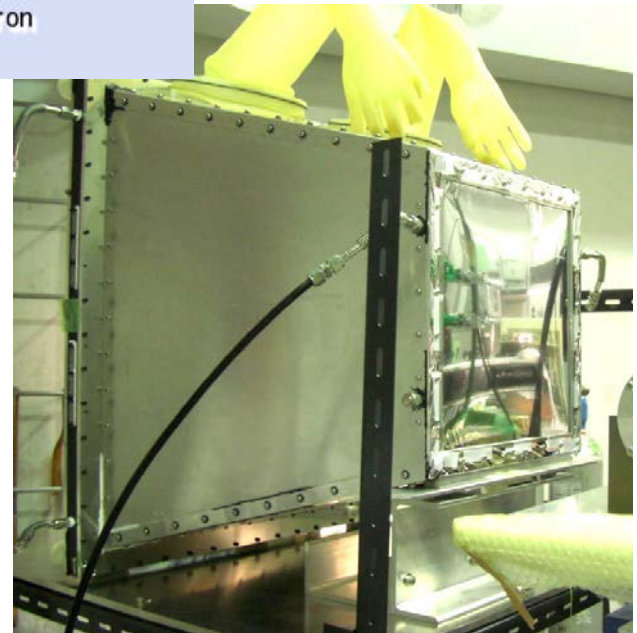
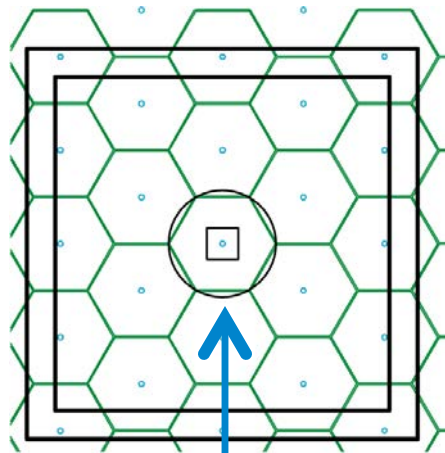
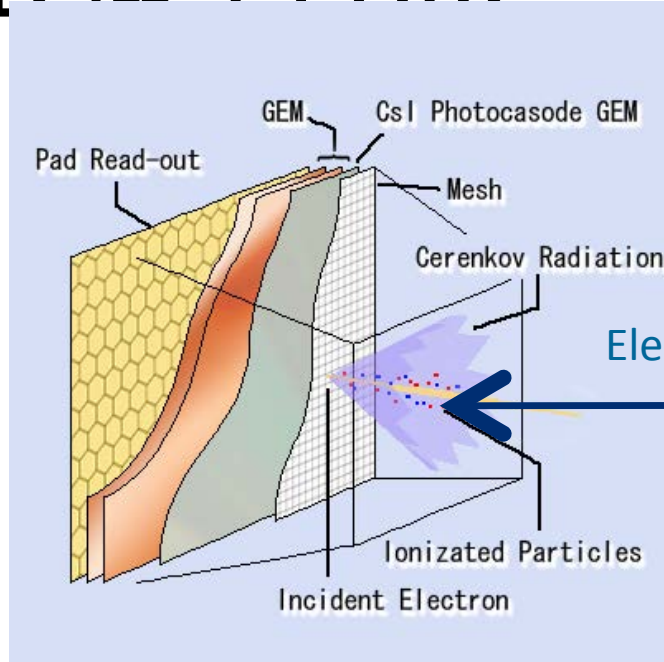
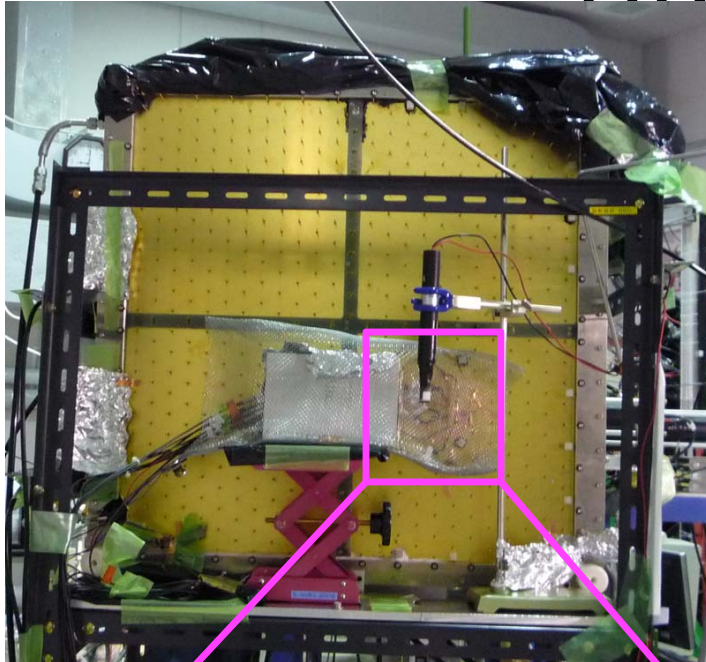

2015/3/13

Cerenkov blob, $\phi \sim 34\text{mm}$

HBD (Hadron Blind Detector)

- Test @ J-PARC K1.1BR in 2013/Jan (T47)
- pion rejection is improved with a higher gain of new PI-GEM and **smaller-size readout pad**
 - **measure the distributed charge: selecting 3 fired pads or more**
- → pion rejection factor 100 with e-efficiency 70% achieved, same level as PHENIX, in spite of the less #p.e.

w/ and w/o cluster size analysis

